

Technical Documentation

APH45085-841
Advantage Plus IEEE 841 | AEHH8B

Date: June 30, 2020

Dimensional Drawing

Catalogue	Model	HP	Pole	kW	Rating	Voltage	Hz	RPM
APH45085-841	AEHH8B	450	8	336	Continuous	575	60	900

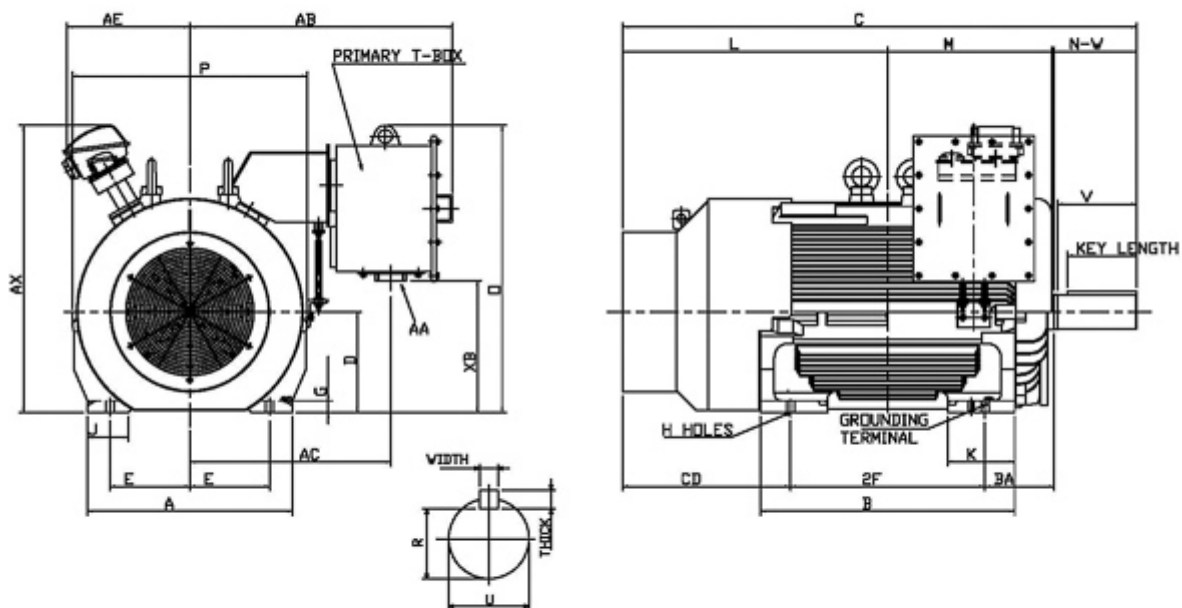

Frame Size	Mounting					A	B	C	CD	D	
	E	2F	2F2	H	BA						
5808B	11.5	28		1.13	10	29.55	36.6	74.08		14.5	
G	J	K	L	M	O	P	T	Key			Keyseat
1.7	5.9	9.65	38.2	23.4	31.45	33.85	16.65	Width	Thick	Length	R
								1.25	1.25	10	4.169
Terminal Housing			Aux Box			C/D Flange					
AA	AB	AC	XB	AE	AX	BB	AH	AK	BD	AJ	BF
	37.86	28.96	19.03	18.34	41.39						
Shaft Extension			Bearings		Approx. Weight Lbs	SPL dBA/3ft	Ins. Class	S.F.	Drive Method	Dimensions	
N-W	U	V	DE	NDE							
11.88	4.875	11.38	6326C3	6322C3	6006	80	F	1.15	Direct Coupling	Inches	

	
	Date: June 30, 2020

Technical Data Sheet

Motor Type: AEHH8B	Catalogue No: APH45085-841
--------------------	----------------------------

Nameplate Information

HP	Pole	RPM	Frame	Voltage	Hz	Phase
450	8	890	5808B	575	60	3
Enclosure	Ins. Class	Service Factor	Time Rating	NEMA Design	Rated Amb.	Rated Altitude
TEFC	F	1.15	Continuous	B	-40 to 40 °C	<1000 m

Typical Performance

Efficiency (%)				Power Factor (%)		
Full Load		3/4 Load	1/2 Load	Full Load	3/4 Load	1/2 Load
Nom.	Min.					
94.5	93.6	94.8	93.6	82.5	80.0	71.0
Torque				Current (A)		
Full Load (lb-ft)	Locked Rotor (% FLT)	Pull Up (% FLT)	Break Down (% FLT)	No Load	Full Load	Locked Rotor
2654.49	90	90	200	147.2	432.4	2600
NEMA KVA Code	Inertia (WR ²)			Safe Stall Time (s)		Noise Level Sound Press. dB(A)
	Rotor (lb-ft ²)	NEMA Load (lb-ft ²)	Max. Allowable (lb-ft ²)	Cold	Hot	
G	582.000	9456.00	18912.00	22	17	80

VFD Duty Information

Speed Range			VFD		S.F.
Constant Torque	Variable Torque	Constant Power	Carrier	Type	
20-60Hz	3-60Hz	60-60Hz	≤ 5 kHz	VPWM or CPWM	1.0 Only

Hazardous Locations Information

CSA Certified
Class I, Div 2, Groups B, C & D Class I, Zone 2, Groups IIB+H2, IIB & IIA
Temp Code (Sinewave / VFD) T3 / T3

Additional Certifications

Other Certification

Additional Information

Bearings		Approx. Weight
DE	NDE	lbs
6326C3	6322C3	6006

Nameplate Drawing

Advantage Plus IEEE 841

TYPE	AEHH8B	CAT. NO.	APH45085-841		
OUTPUT	450 HP 336 kW	FRAME	5808B	TEFC	
R.P.M.	890	POLE	8	INS.	F
VOLTS	575	PHASE	3	Hz	60
AMPS	432.4	CODE	G	S.F.	1.15
AMBIENT	40 °C	NOM. EFF. 94.5		MIN. EFF. 93.6	
BEARINGS	6326C3 / 6322C3			RATING Cont.	
SER. NO.	TBD	DESIGN	B	WT. 6006 LBS	
PWM VFD DUTY	VT	CT	CP	S.F.	
	3-60Hz	20-60Hz	60-60Hz	1.0 Only	

Connection Diagram



3 LEAD		SINGLE VOLTAGE			DELTA
VOLTAGE	CONN.	L1	L2	L3	
-	DELTA	1	2	3	

WD_3D

Thermal Limit Curves

Motor Type: AEHH8B		Catalogue No: APH45085-841		Family: Advantage Plus IEEE 841	
HP	450	Safe Stall Time		Full Load A	432.4 A
Voltage	575V 60Hz	Hot	17 s	% Inrush	601 %
RPM	900	Cold	22 s	Locked Rotor A	2600 A

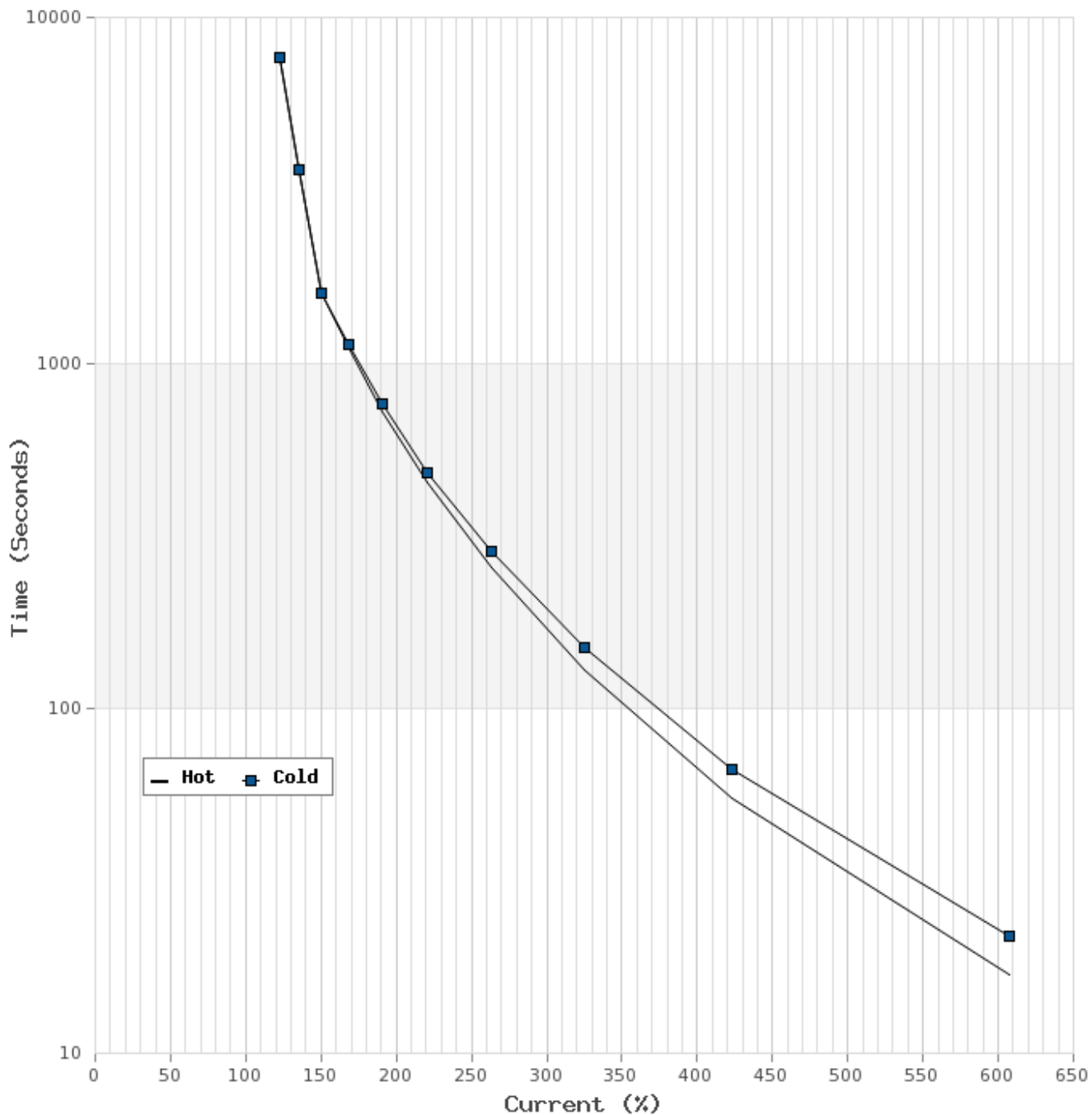

T-N and I-N Curves

Motor Type: AEHH8B		Catalogue No: APH45085-841		Family: Advantage Plus IEEE 841	
HP	450	Full Load T	2654.49 lb-ft	Full Load A	432.4 A
Voltage	575V 60Hz	Locked Rotor T	90 %	Locked Rotor A	2600.0 A
RPM	900	Pull Up T	90 %	Break Down T	200 %

