

Technical Documentation

APH40065-841
Advantage Plus IEEE 841 | AEHH8B

Date: June 30, 2020

Dimensional Drawing

Catalogue	Model	HP	Pole	kW	Rating	Voltage	Hz	RPM
APH40065-841	AEHH8B	400	6	298	Continuous	575	60	1200

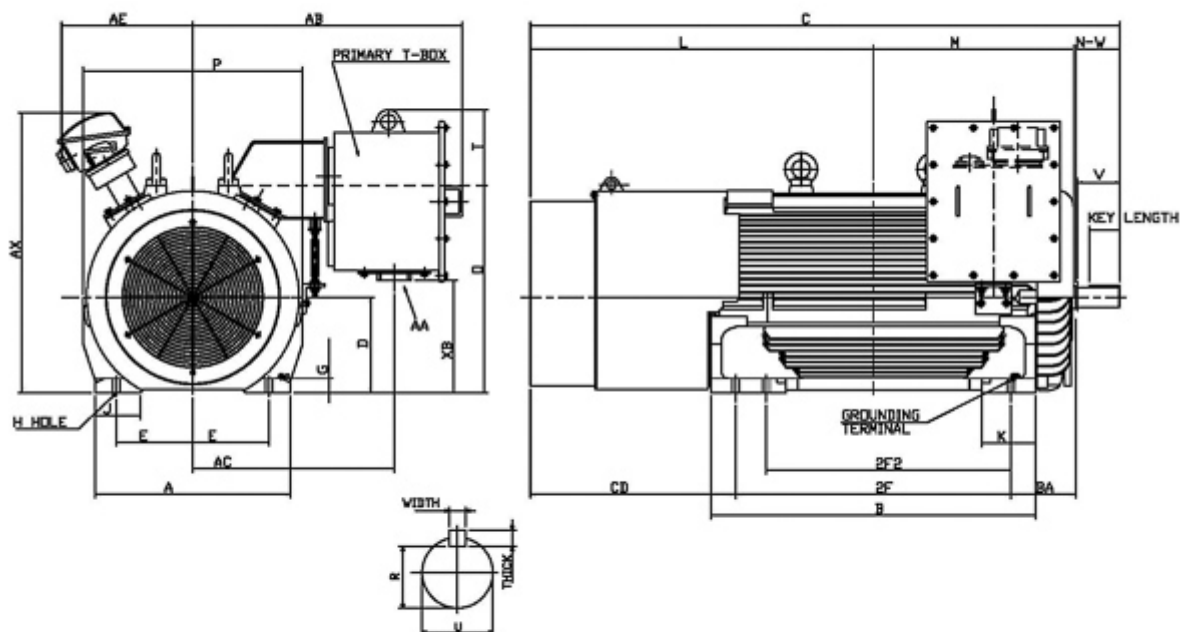

Frame Size	Mounting					A	B	C	CD	D	
	E	2F	2F2	H	BA						
5011B	10	36		0.94	8.5	25.6	42.5	77.67		12.5	
G	J	K	L	M	O	P	T	Key			Keyseat R
								Width	Thick	Length	
1.85	5.9	7.1	39.55	26	27.07	28.75	14.7	1	1	10	3.309
Terminal Housing			Aux Box			C/D Flange					
AA	AB	AC	XB	AE	AX	BB	AH	AK	BD	AJ	BF
	36.95	24.8	14.67	17.83	36.67						
Shaft Extension			Bearings		Approx. Weight Lbs	SPL dBA/3ft	Ins. Class	S.F.	Drive Method	Dimensions	
N-W	U	V	DE	NDE							
11.62	3.875	11.12	6324C3	6320C3	4510	79	F	1.15	Direct Coupling	Inches	

	
	Date: June 30, 2020

Technical Data Sheet

Motor Type: AEHH8B	Catalogue No: APH40065-841
--------------------	----------------------------

Nameplate Information

HP	Pole	RPM	Frame	Voltage	Hz	Phase
400	6	1185	5011B	575	60	3
Enclosure	Ins. Class	Service Factor	Time Rating	NEMA Design	Rated Amb.	Rated Altitude
TEFC	F	1.15	Continuous	B	-40 to 40 °C	<1000 m

Typical Performance

Efficiency (%)				Power Factor (%)		
Full Load		3/4 Load	1/2 Load	Full Load	3/4 Load	1/2 Load
Nom.	Min.					
95.8	95.0	95.4	93.6	87.0	85.0	81.0
Torque				Current (A)		
Full Load (lb-ft)	Locked Rotor (% FLT)	Pull Up (% FLT)	Break Down (% FLT)	No Load	Full Load	Locked Rotor
1770.00	100	100	220	94.7	359.5	2320
NEMA KVA Code	Inertia (WR ²)			Safe Stall Time (s)		Noise Level Sound Press. dB(A)
	Rotor (lb-ft ²)	NEMA Load (lb-ft ²)	Max. Allowable (lb-ft ²)	Cold	Hot	
G	285.000	4199.00	4199.00	21	15	79

VFD Duty Information

Speed Range			VFD		S.F.
Constant Torque	Variable Torque	Constant Power	Carrier	Type	
20-60Hz	3-60Hz	60-60Hz	≤ 5 kHz	VPWM or CPWM	1.0 Only

Hazardous Locations Information

CSA Certified
Class I, Div 2, Groups B, C & D Class I, Zone 2, Groups IIB+H2, IIB & IIA
Temp Code (Sinewave / VFD) T3 / T3

Additional Certifications

Other Certification

Additional Information

Bearings		Approx. Weight
DE	NDE	lbs
6324C3	6320C3	4510

Nameplate Drawing

Advantage Plus IEEE 841

TYPE	AEHH8B	CAT. NO.	APH40065-841		
OUTPUT	400 HP 298 kW	FRAME	5011B	TEFC	
R.P.M.	1185	POLE	6	INS.	F
VOLTS	575	PHASE	3	Hz	60
AMPS	359.5	CODE	G	S.F.	1.15
AMBIENT	40 °C	NOM. EFF. 95.8		MIN. EFF. 95.0	
BEARINGS	6324C3 / 6320C3			RATING Cont.	
SER. NO.	TBD	DESIGN	B	WT. 4510 LBS	
PWM VFD DUTY	VT	CT	CP	S.F.	
	3-60Hz	20-60Hz	60-60Hz	1.0 Only	

Connection Diagram



3 LEAD		SINGLE VOLTAGE			DELTA
VOLTAGE	CONN.	L1	L2	L3	
-	DELTA	1	2	3	

WD_3D

Thermal Limit Curves

Motor Type: AEHH8B		Catalogue No: APH40065-841		Family: Advantage Plus IEEE 841	
HP	400	Safe Stall Time		Full Load A	359.5 A
Voltage	575V 60Hz	Hot	15 s	% Inrush	645 %
RPM	1200	Cold	21 s	Locked Rotor A	2320 A

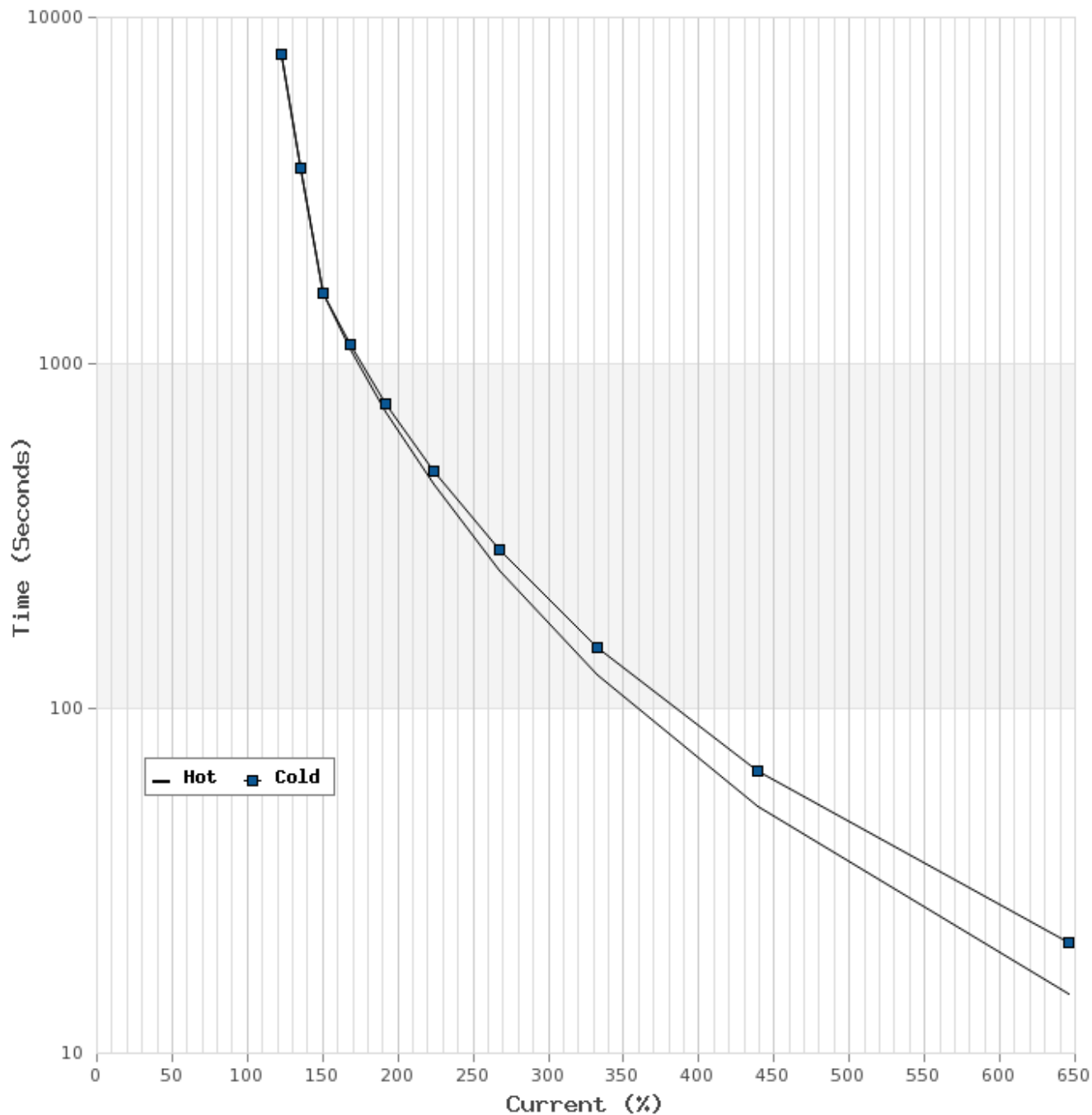

T-N and I-N Curves

Motor Type: AEHH8B		Catalogue No: APH40065-841		Family: Advantage Plus IEEE 841	
HP	400	Full Load T	1770.00 lb-ft	Full Load A	359.5 A
Voltage	575V 60Hz	Locked Rotor T	100 %	Locked Rotor A	2320.0 A
RPM	1200	Pull Up T	100 %	Break Down T	220 %

