

Technical Documentation

APH1508-841

Advantage Plus IEEE 841 | AEHH8B

Date: June 29, 2020

Dimensional Drawing

Catalogue	Model	HP	Pole	kW	Rating	Voltage	Hz	RPM
APH1508-841	AEHH8B	150	8	112	Continuous	460	60	900

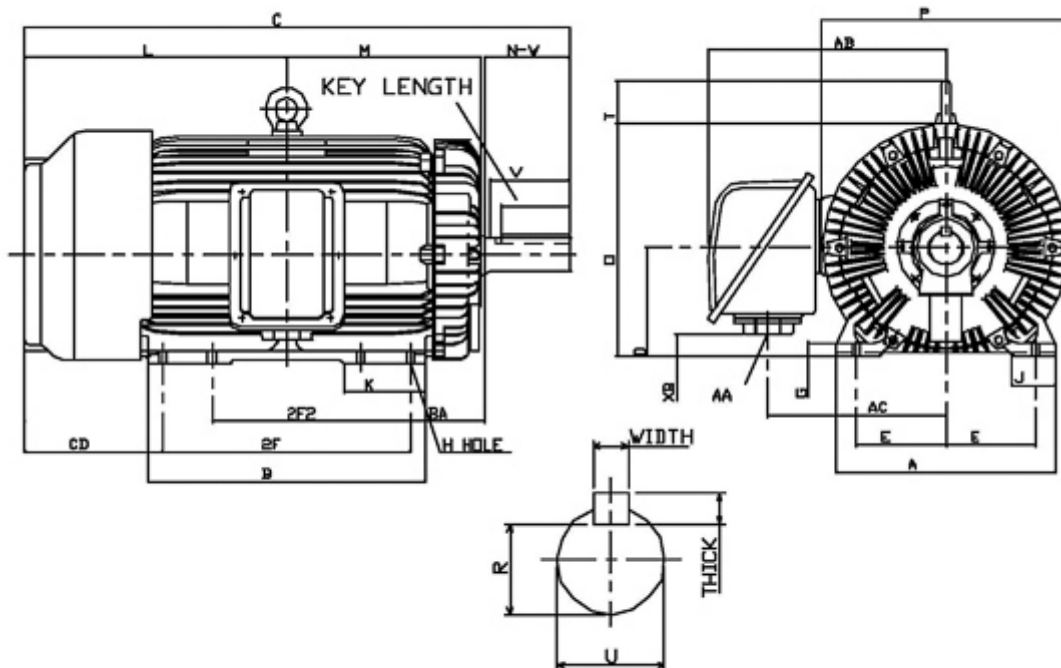

Frame Size	Mounting					A	B	C	CD	D	
	E	2F	2F2	H	BA						
449T	9	25	20	0.81	7.5	22.05	27.95	54.9	13.9	11	
G	J	K	L	M	O	P	T	Key			Keyseat
1.4	4.35	8.25	26.4	19.65	23.55	24.75	7.33	Width	Thick	Length	R
								0.875	0.875	6.91	2.88
Terminal Housing			Aux Box			C/D Flange					
AA	AB	AC	XB	AE	AX	BB	AH	AK	BD	AJ	BF
NPT3"	24	17.9	2.4								
Shaft Extension			Bearings		Approx. Weight Lbs	SPL dBA/3ft	Ins. Class	S.F.	Drive Method	Dimensions	
N-W	U	V	DE	NDE							
8.5	3.375	8	6320C3	6316C3	2378	78	F	1.15	Direct Coupling / Belt Drive	Inches	

	
	Date: June 29, 2020

Technical Data Sheet

Motor Type: AEHH8B	Catalogue No: APH1508-841
--------------------	---------------------------

Nameplate Information

HP	Pole	RPM	Frame	Voltage	Hz	Phase
150	8	888	449T	460	60	3
Enclosure	Ins. Class	Service Factor	Time Rating	NEMA Design	Rated Amb.	Rated Altitude
TEFC	F	1.15	Continuous	B	-40 to 40 °C	<1000 m

Typical Performance

Efficiency (%)				Power Factor (%)		
Full Load		3/4 Load	1/2 Load	Full Load	3/4 Load	1/2 Load
Nom.	Min.					
93.6	92.9	93.4	92.1	80.0	77.0	69.0
Torque				Current (A)		
Full Load (lb-ft)	Locked Rotor (% FLT)	Pull Up (% FLT)	Break Down (% FLT)	No Load	Full Load	Locked Rotor
887.00	150	125	200	62.5	187.6	1085
NEMA KVA Code	Inertia (WR ²)			Safe Stall Time (s)		Noise Level Sound Press. dB(A)
	Rotor (lb-ft ²)	NEMA Load (lb-ft ²)	Max. Allowable (lb-ft ²)	Cold	Hot	
G	166.000	3456.00	6912.00	21	15	78

VFD Duty Information

Speed Range			VFD		S.F.
Constant Torque	Variable Torque	Constant Power	Carrier	Type	
20-60Hz	3-60Hz	60-90Hz	≤ 5 kHz	VPWM or CPWM	1.0 Only

Hazardous Locations Information

CSA Certified
Class I, Div 2, Groups B, C & D Class I, Zone 2, Groups IIB+H2, IIB & IIA
Temp Code (Sinewave / VFD) T3 / T3

Additional Certifications

Other Certification

Additional Information

Bearings		Approx. Weight
DE	NDE	lbs
6320C3	6316C3	2378

Nameplate Drawing

Advantage Plus IEEE 841

TYPE	AEHH8B	CAT. NO.	APH1508-841		
OUTPUT	150 HP 112 kW	FRAME	449T	TEFC	
R.P.M.	888	POLE	8	INS.	F
VOLTS	460	PHASE	3	Hz	60
AMPS	187.6	CODE	G	S.F.	1.15
AMBIENT	40 °C	NOM. EFF. 93.6		MIN. EFF. 92.9	
BEARINGS	6320C3 / 6316C3			RATING Cont.	
SER. NO.	TBD	DESIGN	B	WT. 2378 LBS	
PWM VFD DUTY	VT	CT	CP	S.F.	
	3-60Hz	20-60Hz	60-90Hz	1.0 Only	

Connection Diagram



3 LEAD		SINGLE VOLTAGE			DELTA
VOLTAGE	CONN.	L1	L2	L3	
-	DELTA	1	2	3	

WD_3D

Thermal Limit Curves

Motor Type: AEHH8B		Catalogue No: APH1508-841		Family: Advantage Plus IEEE 841	
HP	150	Safe Stall Time		Full Load A	187.6 A
Voltage	460V 60Hz	Hot	15 s	% Inrush	578 %
RPM	900	Cold	21 s	Locked Rotor A	1085 A

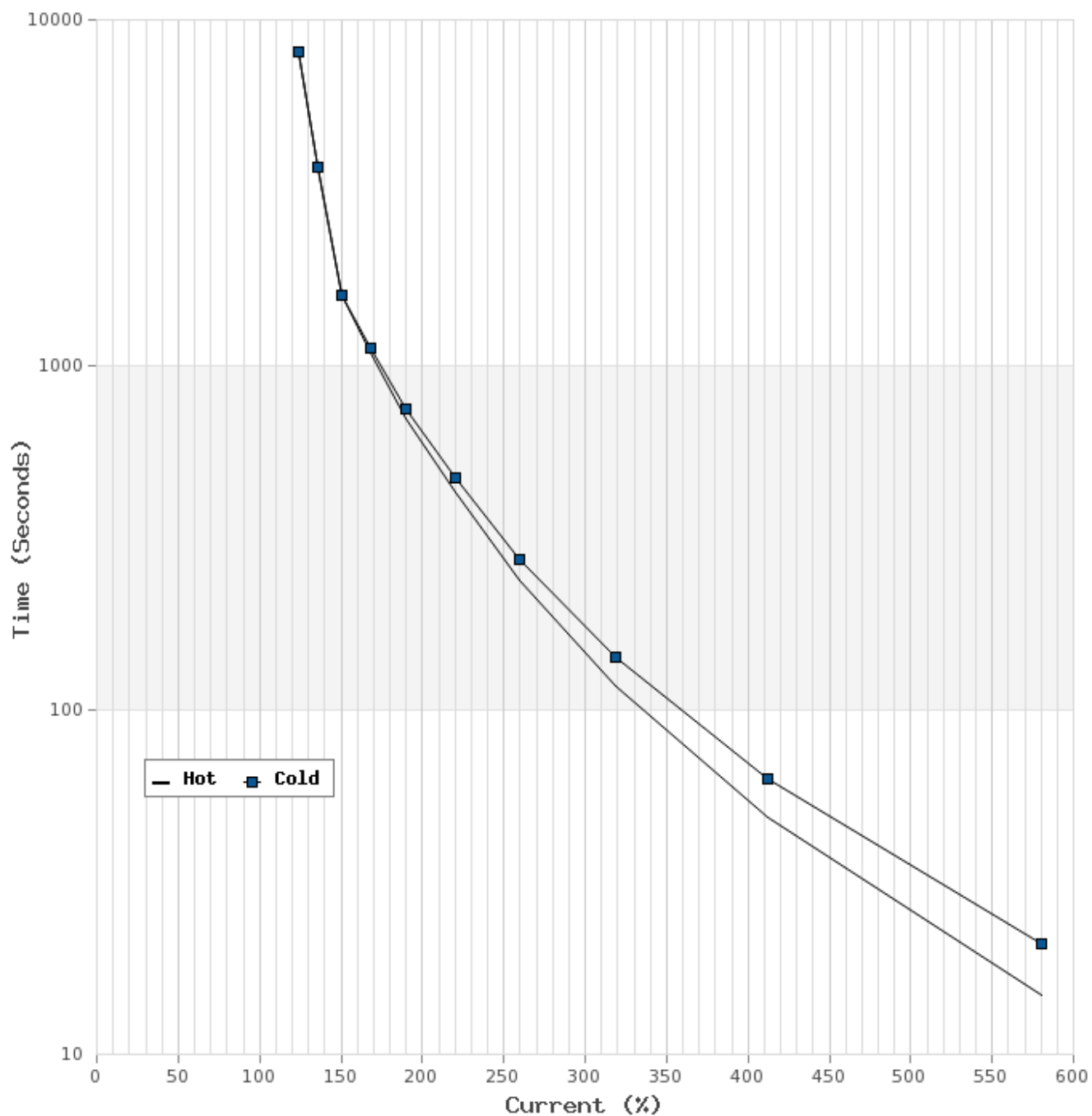

T-N and I-N Curves

Motor Type: AEHH8B		Catalogue No: APH1508-841		Family: Advantage Plus IEEE 841	
HP	150	Full Load T	887.00 lb-ft	Full Load A	187.6 A
Voltage	460V 60Hz	Locked Rotor T	150 %	Locked Rotor A	1085.0 A
RPM	900	Pull Up T	125 %	Break Down T	200 %

