

Technical Documentation

# **CJM0304**

## **Optim JM | AEHH8N\_JM**

Date: November 29, 2016

**Dimensional Drawing**

Catalogue	Model	HP	Pole	kW	Rating	Voltage	Hz	RPM
CJM0304	AEHH8N_JM	30	4	22	Continuous	230 / 460 V	60	1800

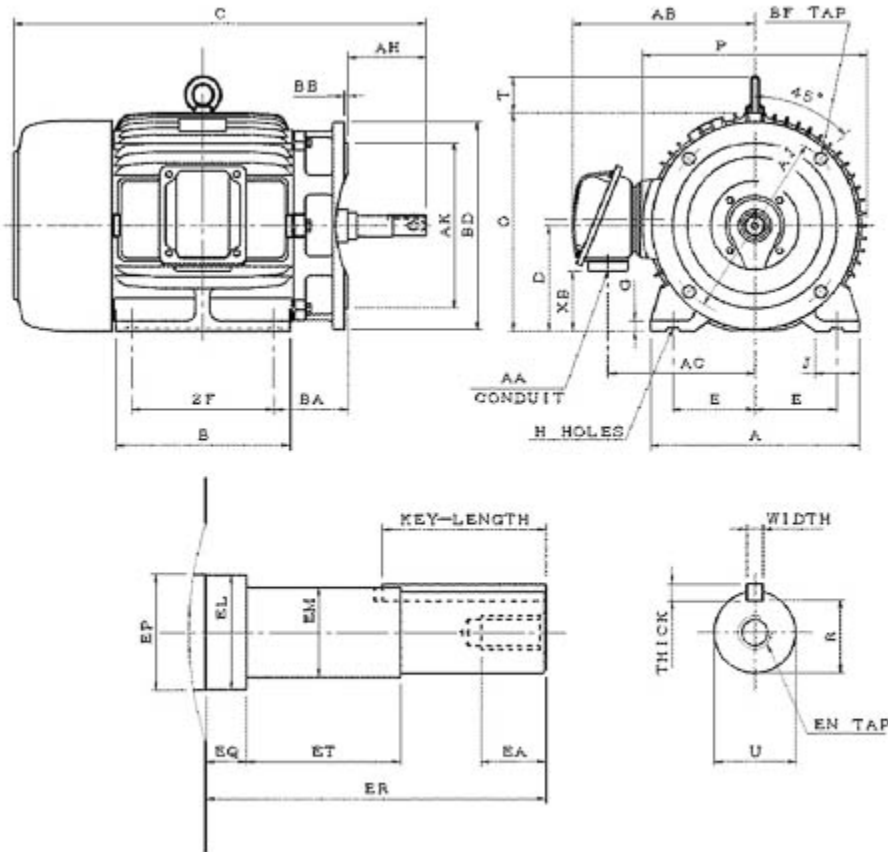

AEHH8N-JM-SMP-5

Frame Size	Mounting					A	B	C	CD	D	
	E	2F	2F2	H	BA						
286JM	5.5	11		0.53	4.95	13.98	13.19	29.13		7	
G	J	K	L	M	O	P	T	Key			Keyseat
0.7	2.95				14.5	15.04	2.36	Width	Thick	Length	R
								0.25	0.25	2.52	1.112
Terminal Housing			Aux Box			C/D Flange					
AA	AB	AC	XB	AE	AX	BB	AH	AK	BD	AJ	BF
1 1/2"	12.28	9.84	3.97			0.2	5.25	12.5	13.78	11	4-5/8"-11UNC
Shaft Extension			Bearings		Approx. Weight Lbs	SPL dBA/3ft	Ins. Class	S.F.	Drive Method	Dimensions	
N-W	U	V	DE	NDE							
	1.25		6311ZZ	6310ZZ	517	70	F	1.15	DirectCoupling	Inches	

### Technical Data Sheet

Motor Type: AEHH8N\_JM

Catalogue No: CJM0304

#### Nameplate Information

HP	Pole	RPM	Frame	Voltage	Hz	Phase
30	4	1765	286JM	230 / 460	60	3
Enclosure	Ins. Class	Service Factor	Time Rating	NEMA Design	Rated Amb.	Rated Altitude
TEFC	F	1.15	Continuous	B	-40 to 40 °C	<3300 ft

#### Typical Performance

Efficiency (%)				Power Factor (%)		
Full Load		3/4 Load	1/2 Load	Full Load	3/4 Load	1/2 Load
Nom.	Min.					
93.6	92.4	93.6	93.6	87.5	85.5	79.5
Torque				Current (A)		
Full Load (lb-ft)	Locked Rotor (% FLT)	Pull Up (% FLT)	Break Down (% FLT)	No Load	Full Load	Locked Rotor
88.99	200	160	235	17.5 / 8.8	68.6 / 34.3	436 / 218
NEMA KVA Code	Inertia (WR <sup>2</sup> )			Safe Stall Time (s)		Noise Level Sound Press. dB(A)
	Rotor (lb-ft <sup>2</sup> )	NEMA Load (lb-ft <sup>2</sup> )	Max. Allowable (lb-ft <sup>2</sup> )	Cold	Hot	
G	5.274	144	328	25	18	70

#### VFD Duty Information

Speed Range			VFD		S.F.
Constant Torque	Variable Torque	Constant Power	Carrier	Type	
6-60Hz	3-60Hz	60-90Hz	≤ 5 kHz	VPWM or CPWM	1.0 Only

#### Additional Information

Bearings		Approx. Weight
DE	NDE	lbs
6311ZZ	6310ZZ	517

#### Hazardous Locations Information

CSA Certified	
Class I, Div 2, Groups B, C & D	
Class I, Zone 2, Groups IIB+H2, IIB & IIA	
Temp Code (Sinewave / VFD)	T3C / T3B

**Connection Diagram**



12 LEAD DUAL VOLTAGE WYE/DELTA						
VOLTAGE	CONNECTION		L1	L2	L3	JOIN
HIGH	START	WYE	1	2	3	4&7,5&8,6&9 10&11&12
	RUN	DELTA	1,12	2,10	3,11	4&7,5&8,6&9
LOW	START	2 WYE	1,7	2,8	3,9	4&5&6 10&11&12
	RUN	2 DELTA	1,6,7 12	2,4,8 10	3,5,9 11	

WD\_12YD

**Thermal Limit Curves**

Motor Type: AEHH8N_JM		Catalogue No: CJM0304		Family: Optim JM	
HP	30	Safe Stall Time		Full Load A	68.6 / 34.3 A
Voltage	230 / 460V 60Hz	Hot	18 s	Locked Rotor A	636 / 636 %
RPM	1800	Cold	25 s	Locked Rotor A	436.0 / 218 A

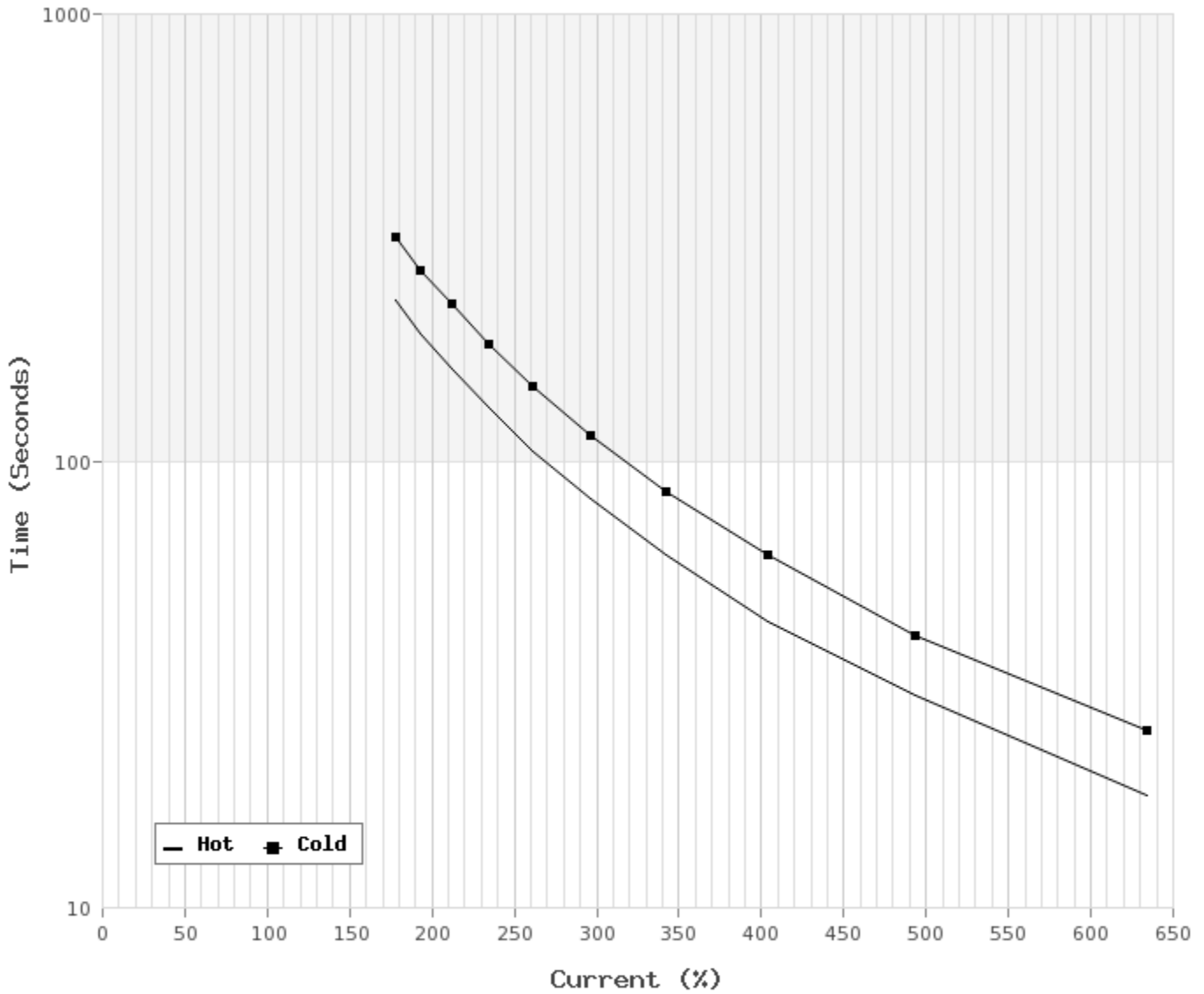

**T-N and I-N Curves**

Motor Type: AEHH8N_JM		Catalogue No: CJM0304		Family: Optim JM	
HP	30	Full Load T	88.99 lb-ft	Full Load A	68.6 / 34.3 A
Voltage	230 / 460V 60Hz	Locked Rotor T	200 %	Locked Rotor A	436.0 / 218.0 A
RPM	1800	Pull Up T	160 %	Break Down T	235 %

