

Technical Documentation

SDP0756

Optim ODP | ASHH

Date: December 1, 2016

Dimensional Drawing

Catalogue	Model	HP	Pole	kW	Rating	Voltage	Hz	RPM
SDP0756	ASHH	75	6	56	Continuous	230 / 460 V	60	1200

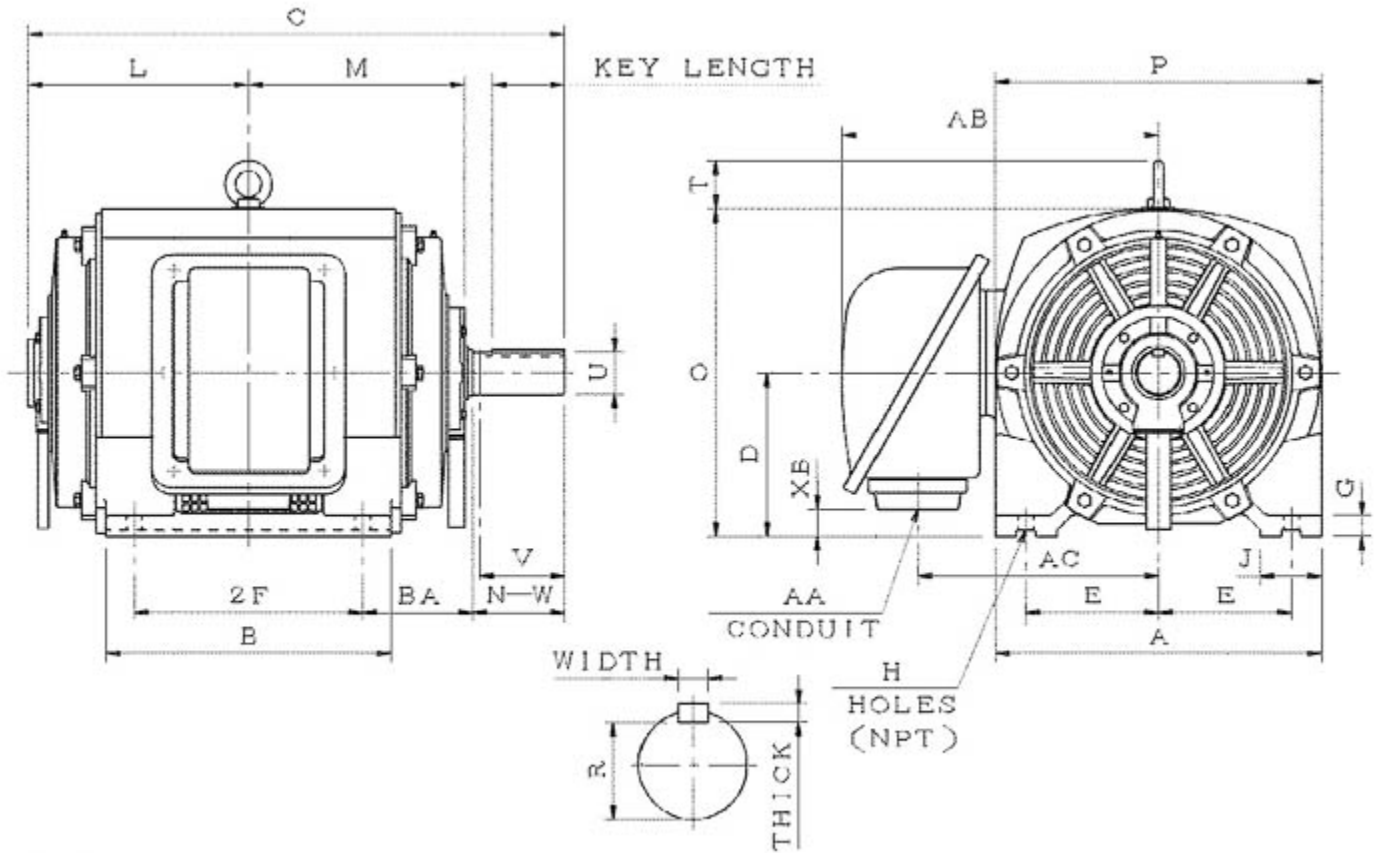

ASHH-SMP-5

Frame Size	Mounting					A	B	C	CD	D	
	E	2F	2F2	H	BA						
405T	8	13.75		0.81	6.62	19.68	17.16	34.33		10	
G	J	K	L	M	O	P	T	Key			Keyseat
1.41	3.74		13.58	12.99	19.96	19.68	3.54	Width	Thick	Length	R
								0.75	0.75	5.65	2.45
Terminal Housing				Aux Box		C/D Flange					
AA	AB	AC	XB	AE	AX	BB	AH	AK	BD	AJ	BF
3	19.4	14.76	1.81								
Shaft Extension			Bearings		Approx. Weight Lbs	SPL dBA/3ft	Ins. Class	S.F.	Drive Method	Dimensions	
N-W	U	V	DE	NDE							
7.25	2.875	7.15	6317	6317	1058	69	F	1.15	Direct Coupling / Belt Drive	Inches	

Technical Data Sheet

Motor Type: ASHH

Catalogue No: SDP0756

Nameplate Information

HP	Pole	RPM	Frame	Voltage	Hz	Phase
75	6	1180	405T	230 / 460	60	3
Enclosure	Ins. Class	Service Factor	Time Rating	NEMA Design	Rated Amb.	Rated Altitude
ODP	F	1.15	Continuous	C	-40 to 40 °C	<3300 ft

Typical Performance

Efficiency (%)				Power Factor (%)		
Full Load		3/4 Load	1/2 Load	Full Load	3/4 Load	1/2 Load
Nom.	Min.					
94.5	93.6	95.0	94.5	86.5	85.5	79.0
Torque				Current (A)		
Full Load (lb-ft)	Locked Rotor (% FLT)	Pull Up (% FLT)	Break Down (% FLT)	No Load	Full Load	Locked Rotor
333.70	220	200	250	51.2 / 25.6	172.0 / 86.0	1085 / 543
NEMA KVA Code	Inertia (WR ²)			Safe Stall Time (s)		Noise Level Sound Press. dB(A)
	Rotor (lb-ft ²)	NEMA Load (lb-ft ²)	Max. Allowable (lb-ft ²)	Cold	Hot	
G	31.371	904	1317	17	12	69

VFD Duty Information

Speed Range			VFD		S.F.
Constant Torque	Variable Torque	Constant Power	Carrier	Type	
6-60Hz	3-60Hz	60-120Hz	≤ 5 kHz	VPWM or CPWM	1.0 Only

Additional Information

Bearings		Approx. Weight
DE	NDE	lbs
6317	6317	1058

Hazardous Locations Information

N/A	
Temp Code (Sinewave / VFD)	/

Connection Diagram



12 LEAD DUAL VOLTAGE WYE/DELTA						
VOLTAGE	CONNECTION		L1	L2	L3	JOIN
HIGH	START	WYE	1	2	3	4&7,5&8,6&9 10&11&12
	RUN	DELTA	1,12	2,10	3,11	4&7,5&8,6&9
LOW	START	2 WYE	1,7	2,8	3,9	4&5&6 10&11&12
	RUN	2 DELTA	1,6,7 12	2,4,8 10	3,5,9 11	

WD_12YD

Thermal Limit Curves

Motor Type: ASHH		Catalogue No: SDP0756		Family: Optim ODP	
HP	75	Safe Stall Time		Full Load A	172.0 / 86.0 A
Voltage	230 / 460V 60Hz	Hot	12 s	Locked Rotor A	631 / 631 %
RPM	1200	Cold	17 s	Locked Rotor A	1,085.0 / 543 A

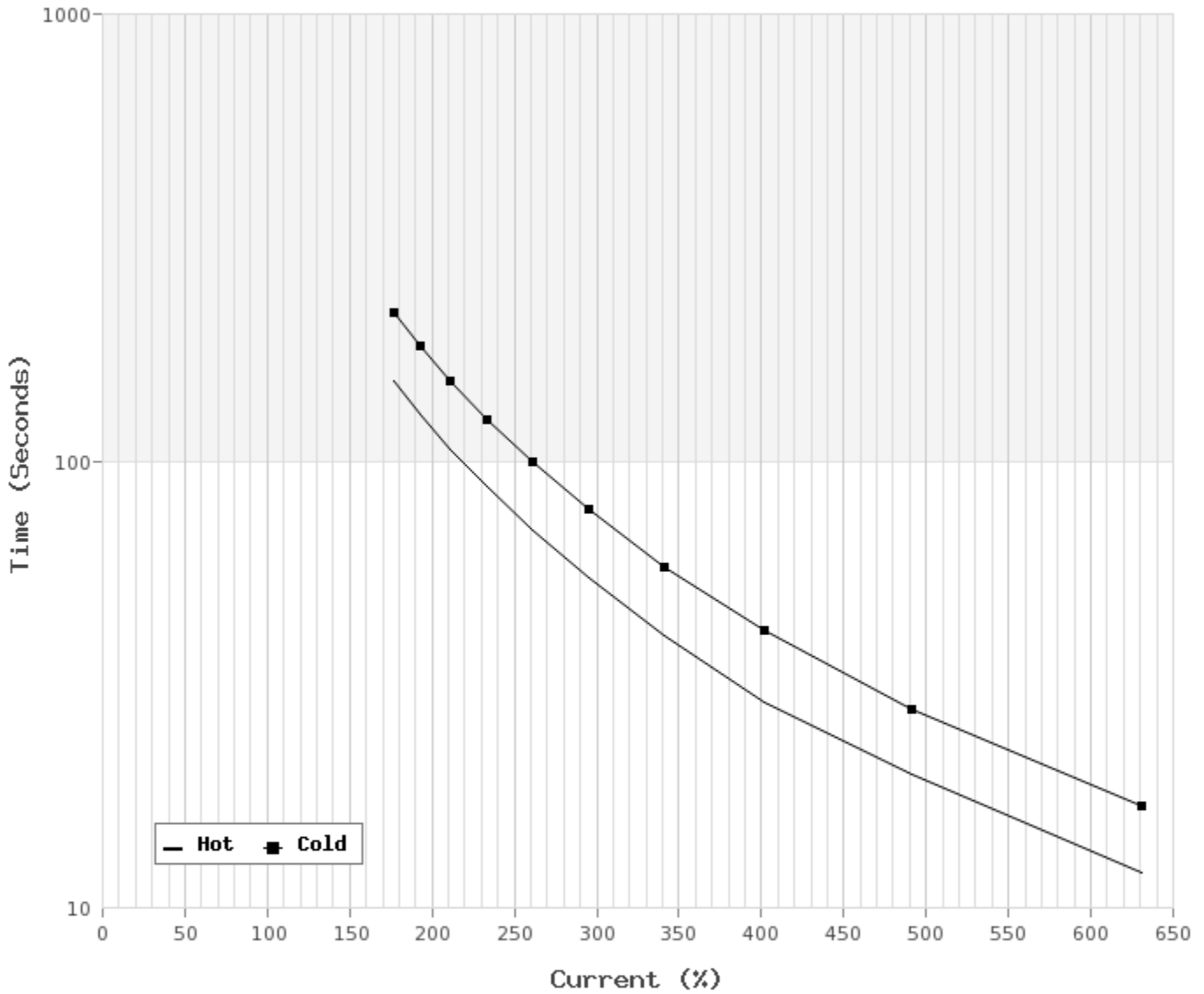

T-N and I-N Curves

Motor Type: ASHH		Catalogue No: SDP0756		Family: Optim ODP	
HP	75	Full Load T	333.70 lb-ft	Full Load A	172.0 / 86.0 A
Voltage	230 / 460V 60Hz	Locked Rotor T	220 %	Locked Rotor A	1,085.0 / 543.0 A
RPM	1200	Pull Up T	200 %	Break Down T	250 %

