

Technical Documentation

RD0252
Rolled Steel ODP | ASGH

Date: December 1, 2016

Dimensional Drawing

Catalogue	Model	HP	Pole	kW	Rating	Voltage	Hz	RPM
RD0252	ASGH	25	2	19	Continuous	230 / 460 V	60	3600

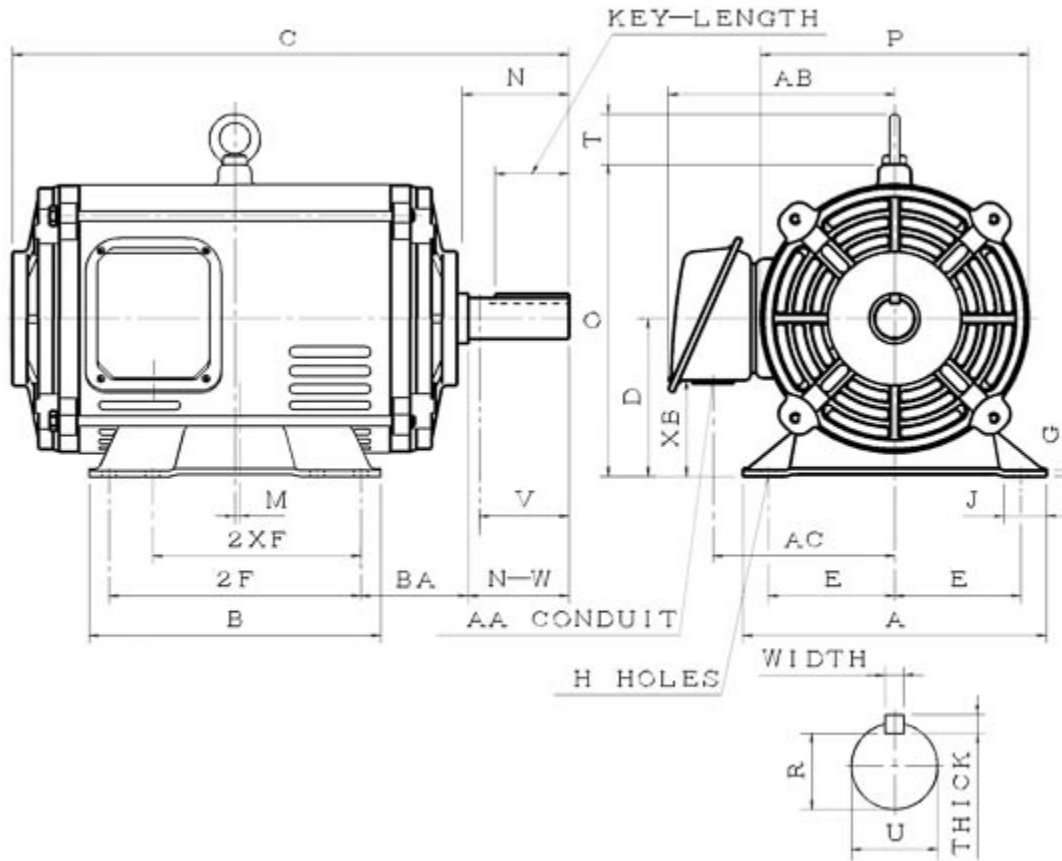

ASGH-SMP-5

Frame Size	Mounting					A	B	C	CD	D	
	E	2F	2F2	H	BA						
256T	10	10		0.53	4.25	12.05	11.57	22.48		6.25	
G	J	K	L	M	O	P	T	Key			Keyseat
0.24	1.65			0.197	12.55	10.79	2	Width	Thick	Length	R
								0.375	0.375	2.91	1.416
Terminal Housing				Aux Box		C/D Flange					
AA	AB	AC	XB	AE	AX	BB	AH	AK	BD	AJ	BF
1.38	8.99	7.2	3.81								
Shaft Extension			Bearings		Approx. Weight Lbs	SPL dBA/3ft	Ins. Class	S.F.	Drive Method	Dimensions	
N-W	U	V	DE	NDE							
4	1.625	3.9	6309ZZC3	6208ZZC3	202	71	F	1.15	Direct Coupling / Belt Drive	Inches	

Technical Data Sheet

Motor Type: ASGH

Catalogue No: RD0252

Nameplate Information

HP	Pole	RPM	Frame	Voltage	Hz	Phase
25	2	3530	256T	230 / 460	60	3
Enclosure	Ins. Class	Service Factor	Time Rating	NEMA Design	Rated Amb.	Rated Altitude
ODP	F	1.15	Continuous	B	-40 to 40 °C	<3300 ft

Typical Performance

Efficiency (%)				Power Factor (%)		
Full Load		3/4 Load	1/2 Load	Full Load	3/4 Load	1/2 Load
Nom.	Min.					
91.7	90.2	92.0	92.0	91.0	90.0	85.0
Torque				Current (A)		
Full Load (lb-ft)	Locked Rotor (% FLT)	Pull Up (% FLT)	Break Down (% FLT)	No Load	Full Load	Locked Rotor
37.18	210	155	250	12.5 / 6.3	56.1 / 28.1	365 / 15
NEMA KVA Code	Inertia (WR ²)			Safe Stall Time (s)		Noise Level Sound Press. dB(A)
	Rotor (lb-ft ²)	NEMA Load (lb-ft ²)	Max. Allowable (lb-ft ²)	Cold	Hot	
G	1.213	26	38	17	12	71

VFD Duty Information

Speed Range			VFD		S.F.
Constant Torque	Variable Torque	Constant Power	Carrier	Type	
6-60Hz	3-60Hz	60-120Hz	≤ 5 kHz	VPWM or CPWM	1.0 Only

Additional Information

Bearings		Approx. Weight
DE	NDE	lbs
6309ZZC3	6208ZZC3	202

Hazardous Locations Information

N/A	
Temp Code (Sinewave / VFD)	/

Connection Diagram



12 LEAD DUAL VOLTAGE WYE/DELTA						
VOLTAGE	CONNECTION		L1	L2	L3	JOIN
HIGH	START	WYE	1	2	3	4&7,5&8,6&9 10&11&12
	RUN	DELTA	1,12	2,10	3,11	4&7,5&8,6&9
LOW	START	2 WYE	1,7	2,8	3,9	4&5&6 10&11&12
	RUN	2 DELTA	1,6,7 12	2,4,8 10	3,5,9 11	

WD_12YD

Thermal Limit Curves

Motor Type: ASGH		Catalogue No: RD0252		Family: Rolled Steel ODP	
HP	25	Safe Stall Time		Full Load A	56.1 / 28.1 A
Voltage	230 / 460V 60Hz	Hot	12 s	Locked Rotor A	651 / 53 %
RPM	3600	Cold	17 s	Locked Rotor A	365.0 / 15 A

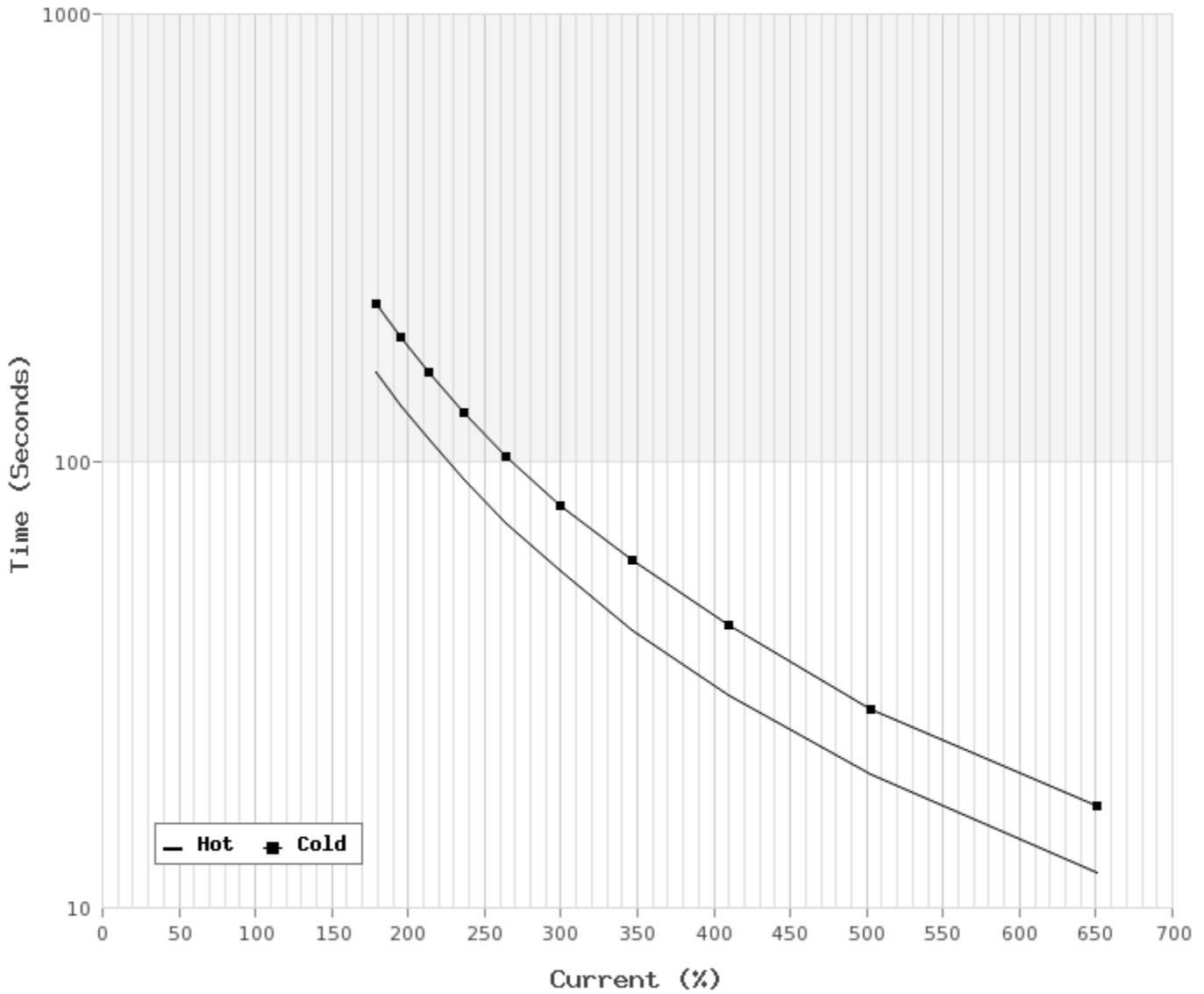

T-N and I-N Curves

Motor Type: ASGH		Catalogue No: RD0252		Family: Rolled Steel ODP	
HP	25	Full Load T	37.18 lb-ft	Full Load A	56.1 / 28.1 A
Voltage	230 / 460V 60Hz	Locked Rotor T	210 %	Locked Rotor A	365.0 / 15.0 A
RPM	3600	Pull Up T	155 %	Break Down T	250 %

