

Technical Documentation

SDP25045

Optim ODP | ASHH

Date: December 1, 2016

Dimensional Drawing

Catalogue	Model	HP	Pole	kW	Rating	Voltage	Hz	RPM
SDP25045	ASHH	250	4	186.5	Continuous	575 V	60	1800

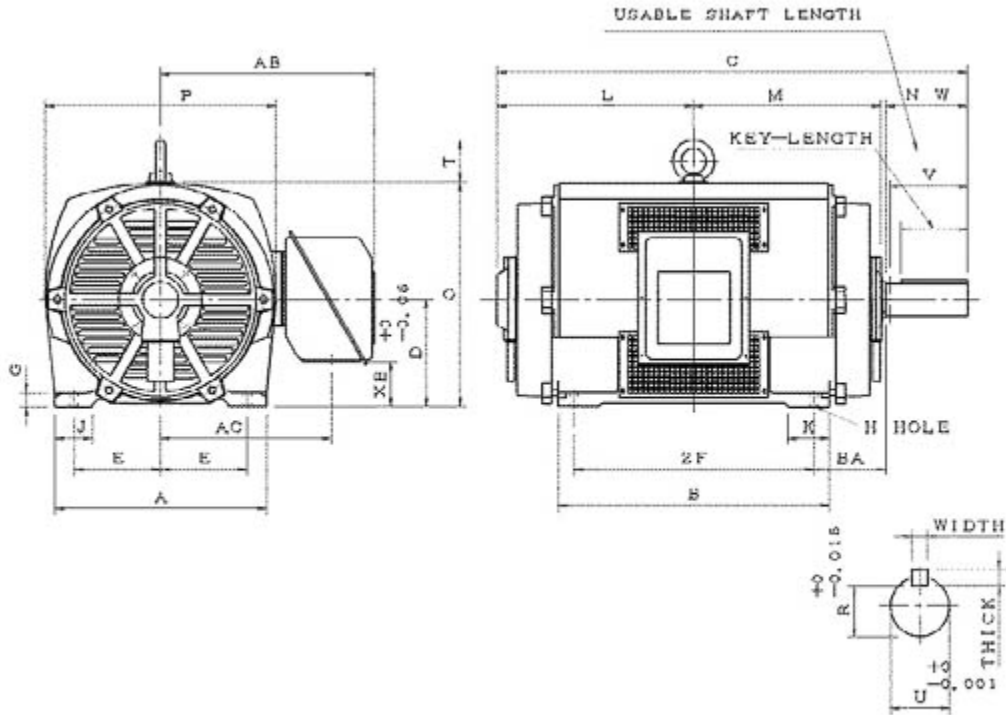

ASHH-HMP-1 1 0

Frame Size	Mounting					A	B	C	CD	D	
	E	2F	2F2	H	BA						
447T	9	20		0.81	7.5	22.05	23.25	43.95		11	
G	J	K	L	M	O	P	T	Key			Keyseat
1.4	3.95	4.35	17.95	17.35	23.15	24	4.35	Width	Thick	Length	R
								0.875	0.875	6.91	2.88
Terminal Housing				Aux Box		C/D Flange					
AA	AB	AC	XB	AE	AX	BB	AH	AK	BD	Aj	BF
	22.25	17.7	4.65								
Shaft Extension			Bearings		Approx. Weight Lbs	SPL dBA/3ft	Ins. Class	S.F.	Drive Method	Dimensions	
N-W	U	V	DE	NDE							
8.5	3.375	8	6320	6318	1760	82	F	1.15	Direct Coupling / Belt Drive	Inches	

Technical Data Sheet

Motor Type: ASHH

Catalogue No: SDP25045

Nameplate Information

HP	Pole	RPM	Frame	Voltage	Hz	Phase
250	4	1782	447T	575	60	3
Enclosure	Ins. Class	Service Factor	Time Rating	NEMA Design	Rated Amb.	Rated Altitude
ODP	F	1.15	Continuous	B	-40 to 40 °C	<3300 ft

Typical Performance

Efficiency (%)				Power Factor (%)		
Full Load		3/4 Load	1/2 Load	Full Load	3/4 Load	1/2 Load
Nom.	Min.					
95.8	95.0	95.4	94.5	87.0	83.5	80.5
Torque				Current (A)		
Full Load (lb-ft)	Locked Rotor (% FLT)	Pull Up (% FLT)	Break Down (% FLT)	No Load	Full Load	Locked Rotor
737.00	125	105	205	70.7	224.8	1460
NEMA KVA Code	Inertia (WR ²)			Safe Stall Time (s)		Noise Level Sound Press. dB(A)
	Rotor (lb-ft ²)	NEMA Load (lb-ft ²)	Max. Allowable (lb-ft ²)	Cold	Hot	
G	65.000	1017	2034	18	12	82

VFD Duty Information

Speed Range			VFD		S.F.
Constant Torque	Variable Torque	Constant Power	Carrier	Type	
6-60Hz	3-60Hz	60-120Hz	≤ 5 kHz	VPWM or CPWM	1.0 Only

Additional Information

Bearings		Approx. Weight
DE	NDE	lbs
6320	6318	1760

Hazardous Locations Information

N/A	
0	
0	
Temp Code (Sinewave / VFD)	0 / 0

Connection Diagram



3 LEAD SINGLE VOLTAGE DELTA					
VOLTAGE	CONN.	L1	L2	L3	
-	DELTA	1	2	3	

WD_3D

Thermal Limit Curves

Motor Type: ASHH		Catalogue No: SDP25045		Family: Optim ODP	
HP	250	Safe Stall Time		Full Load A	0.0 / 224.8 A
Voltage	0 / 575V 60Hz	Hot	12 s	Locked Rotor A	649 %
RPM	1800	Cold	18 s	Locked Rotor A	0.0 / 1 A

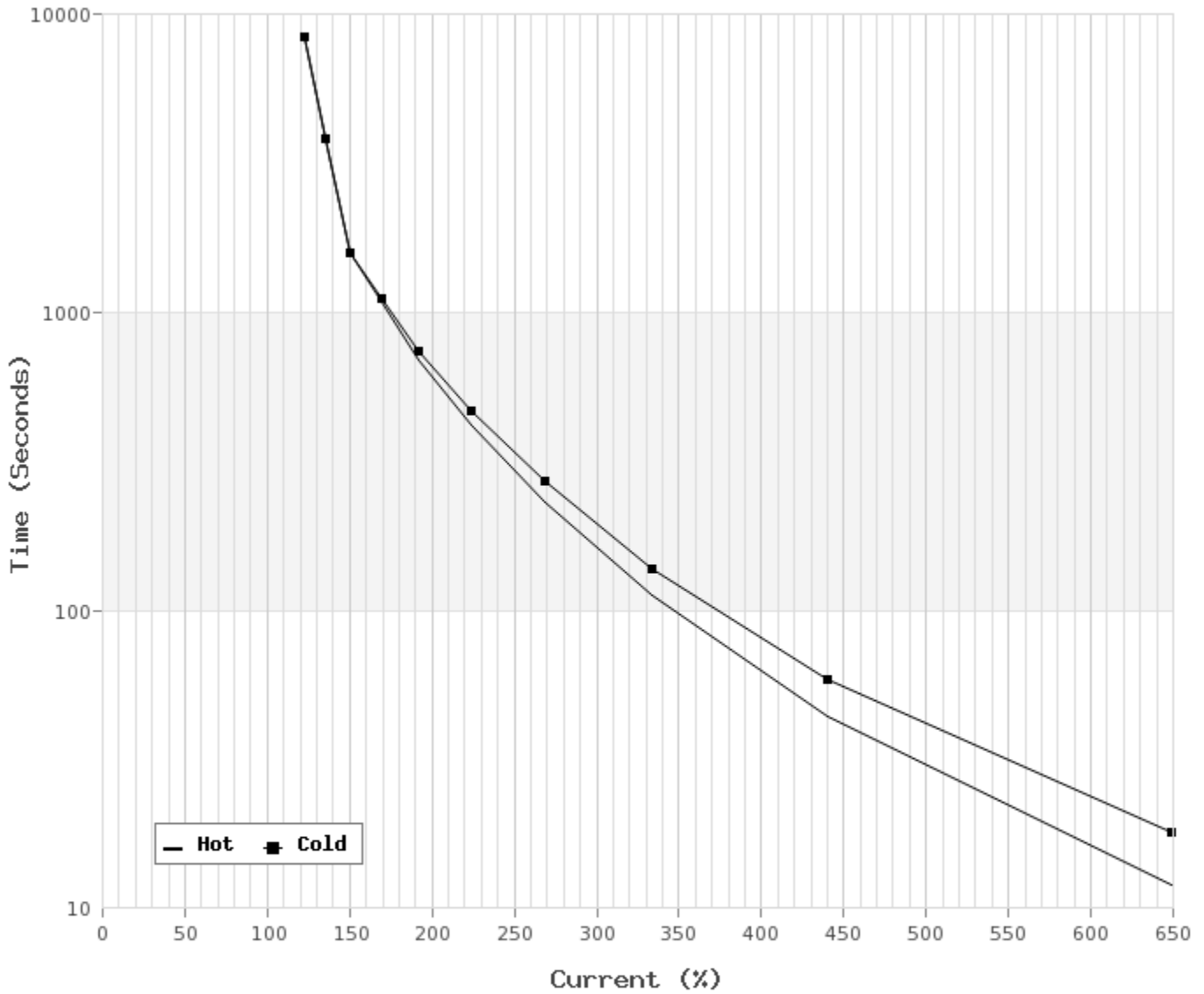

T-N and I-N Curves

Motor Type: ASHH		Catalogue No: SDP25045		Family: Optim ODP	
HP	250	Full Load T	737.00 lb-ft	Full Load A	224.8 A
Voltage	575V 60Hz	Locked Rotor T	125 %	Locked Rotor A	1,460.0 A
RPM	1800	Pull Up T	105 %	Break Down T	205 %

