

Technical Documentation

APH07545
Advantage Plus IEEE Ready | AEHH8R

Date: June 26, 2020

Dimensional Drawing

Catalogue	Model	HP	Pole	kW	Rating	Voltage	Hz	RPM
APH07545	AEHH8R	75	4	56	Continuous	575	60	1800

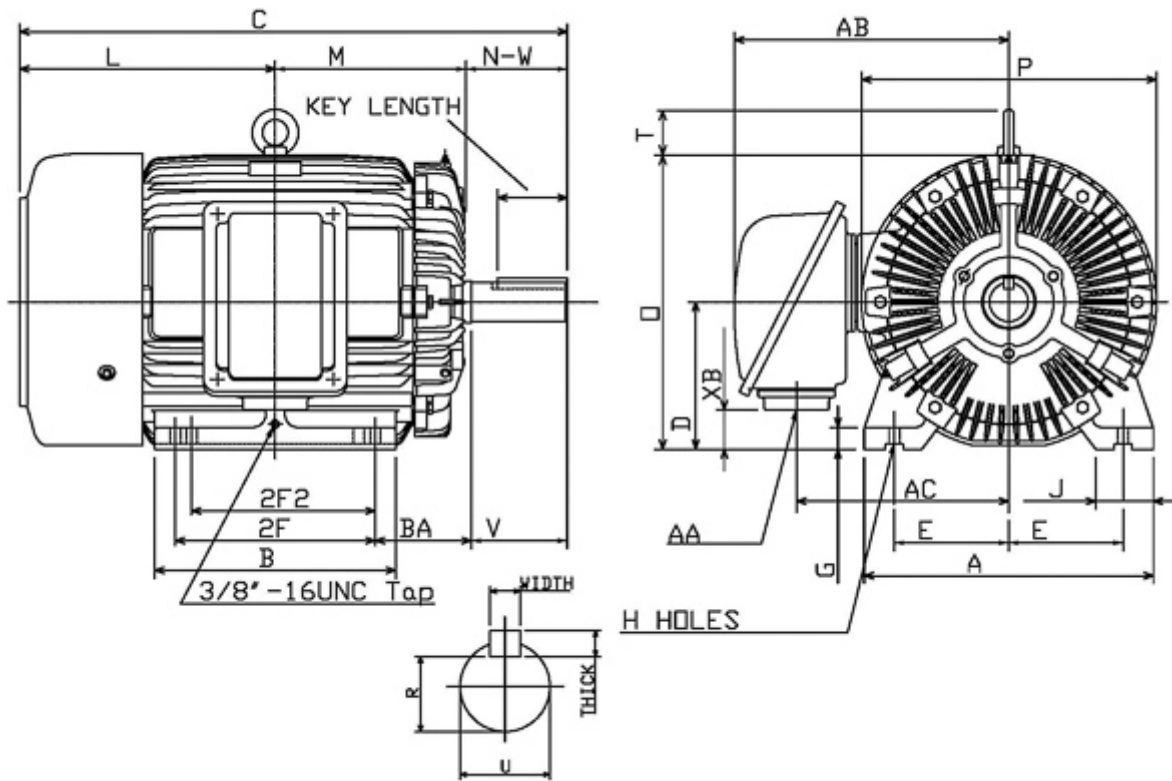

Frame Size	Mounting					A	B	C	CD	D	
	E	2F	2F2	H	BA						
365T	7	12.25	11.25	0.66	5.88	17.7	14.76	33.55		9	
G	J	K	L	M	O	P	T	Key			Keyseat R
								Width	Thick	Length	
1.32	3.54		15.67	11.59	17.99	18.03	2.76	0.625	0.625	4.28	2.021
Terminal Housing			Aux Box			C/D Flange					
AA	AB	AC	XB	AE	AX	BB	AH	AK	BD	AJ	BF
NPT3"	16.81	12.99	2.39								
Shaft Extension			Bearings		Approx. Weight Lbs	SPL dBA/3ft	Ins. Class	S.F.	Drive Method	Dimensions	
N-W	U	V	DE	NDE							
5.88	2.375	5.75	6313ZC3	6213ZC3	913	79	F	1.15	Direct Coupling / Belt Drive	Inches	

	
	Date: June 26, 2020

Technical Data Sheet

Motor Type: AEHH8R	Catalogue No: APH07545
--------------------	------------------------

Nameplate Information

HP	Pole	RPM	Frame	Voltage	Hz	Phase
75	4	1775	365T	575	60	3
Enclosure	Ins. Class	Service Factor	Time Rating	NEMA Design	Rated Amb.	Rated Altitude
TEFC	F	1.15	Continuous	B	-40 to 40 °C	<1000 m

Typical Performance

Efficiency (%)				Power Factor (%)		
Full Load		3/4 Load	1/2 Load	Full Load	3/4 Load	1/2 Load
Nom.	Min.					
95.4	94.5	95.4	95.0	86.5	83.5	75.5
Torque				Current (A)		
Full Load (lb-ft)	Locked Rotor (% FLT)	Pull Up (% FLT)	Break Down (% FLT)	No Load	Full Load	Locked Rotor
221.80	200	165	250	20.8	68.1	434
NEMA KVA Code	Inertia (WR ²)			Safe Stall Time (s)		Noise Level Sound Press. dB(A)
	Rotor (lb-ft ²)	NEMA Load (lb-ft ²)	Max. Allowable (lb-ft ²)	Cold	Hot	
G	14.674	338.00	618.00	17	12	79

VFD Duty Information

Speed Range			VFD		S.F.
Constant Torque	Variable Torque	Constant Power	Carrier	Type	
6-60Hz	3-60Hz	60-90Hz	≤ 5 kHz	VPWM or CPWM	1.0 Only

Hazardous Locations Information

CSA Certified
Class I, Div 2, Groups B, C & D Class I, Zone 2, Groups IIB+H2, IIB & IIA
Temp Code (Sinewave / VFD)
T3C / T3

Additional Certifications

Other Certification
Class II, Div 2, Groups F & G

Additional Information

Bearings		Approx. Weight
DE	NDE	lbs
6313ZC3	6213ZC3	913

Nameplate Drawing

Advantage Plus IEEE Ready

TYPE	AEHH8R	CAT. NO.	APH07545		
OUTPUT	75 HP 56 kW	FRAME	365T	TEFC	
R.P.M.	1775	POLE	4	INS.	F
VOLTS	575	PHASE	3	Hz	60
AMPS	68.1	CODE	G	S.F.	1.15
AMBIENT	40 °C	NOM. EFF. 95.4		MIN. EFF. 94.5	
BEARINGS	6313ZC3 / 6213ZC3			RATING Cont.	
SER. NO.	TBD	DESIGN	B	WT. 913 LBS	
PWM VFD DUTY	VT	CT	CP	S.F.	
	3-60Hz	6-60Hz	60-90Hz	1.0 Only	

Connection Diagram



3 LEAD		SINGLE VOLTAGE			DELTA
VOLTAGE	CONN.	L1	L2	L3	
-	DELTA	1	2	3	

WD_3D

Thermal Limit Curves

Motor Type: AEHH8R		Catalogue No: APH07545		Family: Advantage Plus IEEE Ready	
HP	75	Safe Stall Time		Full Load A	68.1 A
Voltage	575V 60Hz	Hot	12 s	% Inrush	637 %
RPM	1800	Cold	17 s	Locked Rotor A	434 A

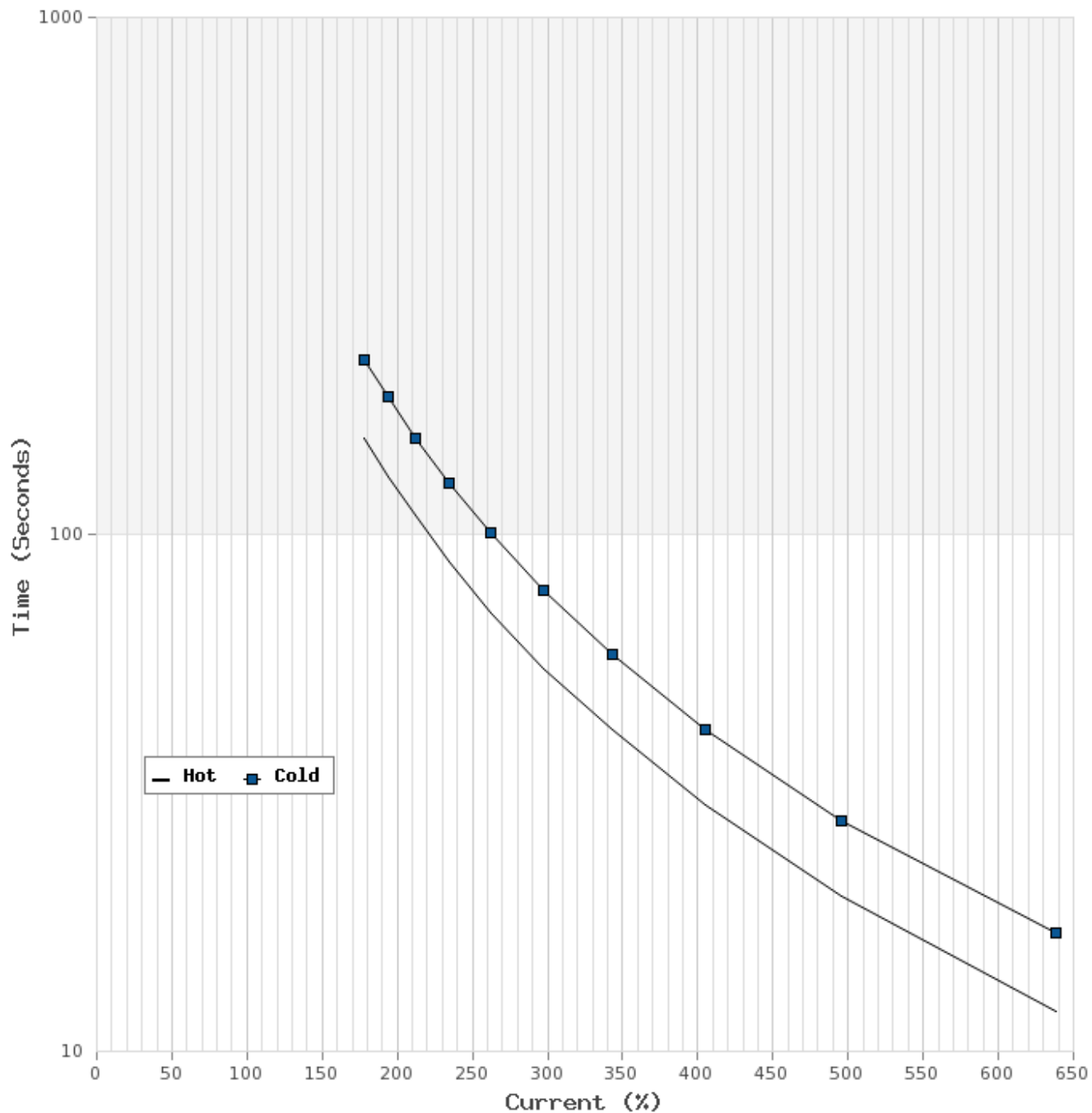

T-N and I-N Curves

Motor Type: AEHH8R		Catalogue No: APH07545		Family: Advantage Plus IEEE Ready	
HP	75	Full Load T	221.80 lb-ft	Full Load A	68.1 A
Voltage	575V 60Hz	Locked Rotor T	200 %	Locked Rotor A	434.0 A
RPM	1800	Pull Up T	165 %	Break Down T	250 %

