

Technical Documentation

RF0/545C
Rolled Steel TEFC | AEGHPE

Date: July 10, 2017

Dimensional Drawing

Catalogue	Model	HP	Pole	kW	Rating	Voltage	Hz	RPM
RF0/545C	AEGHPE	0.50	4	0.37	Continuous	575 V	60	1800

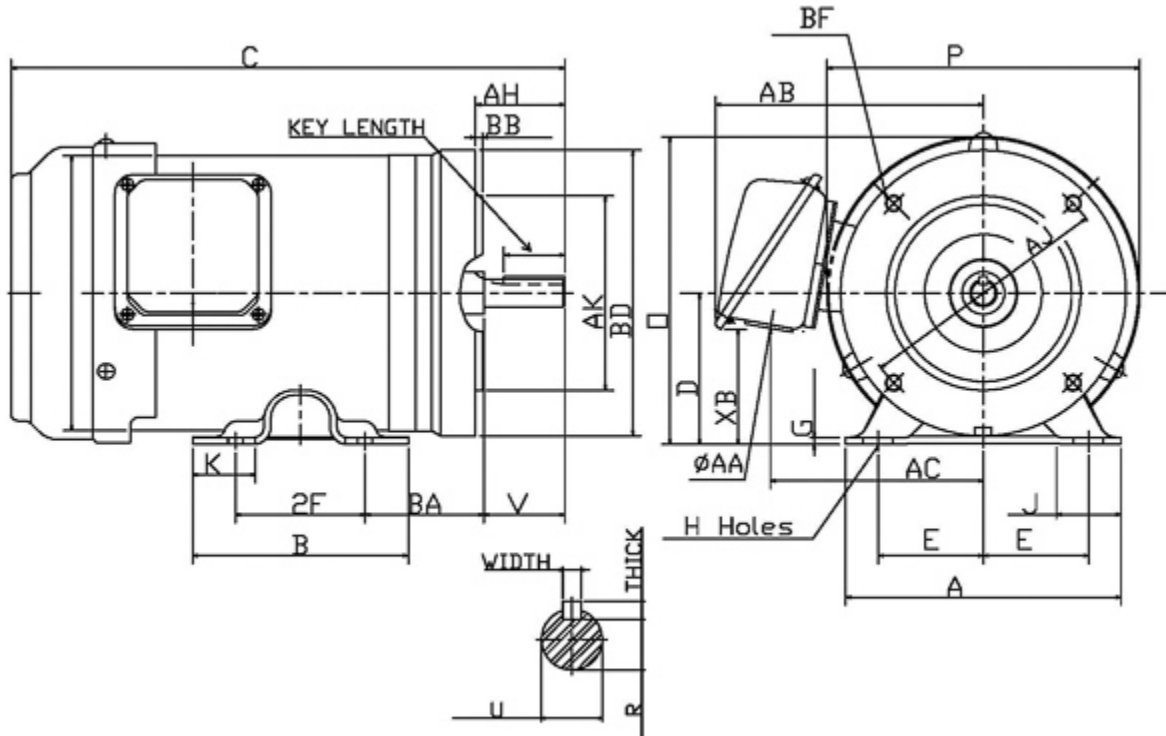

Frame Size	Mounting					A	B	C	CD	D	
	E	2F	2F2	H	BA						
56C	2.44	3		0.34x0.68	2.75	6.38	3.94	12.16		3.5	
G	J	K	L	M	O	P	T	Key			Keyseat
								Width	Thick	Length	R
0.16	1.54				6.72	6.61		0.188	0.188	1.41	0.517
Terminal Housing			Aux Box			C/D Flange					
AA	AB	AC	XB	AE	AX	BB	AH	AK	BD	AJ	BF
1.1	5.87	4.64	2.61			0.16	2.06	4.5	6.61	5.875	3/8-16
Shaft Extension			Bearings		Approx. Weight Lbs	SPL dBA/3ft	Ins. Class	S.F.	Drive Method	Dimensions	
N-W	U	V	DE	NDE							
1.875	0.625	1.88	6204ZZ	6203ZZ	25	54	F	1.15	Direct Coupling / Belt Drive	Inches	

Technical Data Sheet

Motor Type: AEGHPE

Catalogue No: RF0/545C

Nameplate Information

HP	Pole	RPM	Frame	Voltage	Hz	Phase
0.50	4	1725	56C	575	60	3
Enclosure	Ins. Class	Service Factor	Time Rating	NEMA Design	Rated Amb.	Rated Altitude
TEFC	F	1.15	Continuous	B	-40 to 40°C °C	<3300 ft

Typical Performance

Efficiency (%)				Power Factor (%)		
Full Load		3/4 Load	1/2 Load	Full Load	3/4 Load	1/2 Load
Nom.	Min.					
78.2	75.0	74.5	70.0	81.0	64.5	51.5
Torque				Current (A)		
Full Load (lb-ft)	Locked Rotor (% FLT)	Pull Up (% FLT)	Break Down (% FLT)	No Load	Full Load	Locked Rotor
1.51	270	240	370	0.5	0.6	4
NEMA KVA Code	Inertia (WR ²)			Safe Stall Time (s)		Noise Level Sound Press. dB(A)
	Rotor (lb-ft ²)	NEMA Load (lb-ft ²)	Max. Allowable (lb-ft ²)	Cold	Hot	
J	0.037	4.7	48.13	99	69	54

VFD Duty Information

Speed Range			VFD		S.F.
Constant Torque	Variable Torque	Constant Power	Carrier	Type	
6-60Hz	3-60Hz	60-120Hz	≤ 5 kHz	VPWM or CPWM	1.0 Only

Additional Information

Bearings		Approx. Weight
DE	NDE	lbs
6204ZZ	6203ZZ	25

Hazardous Locations Information

N/A	
0	
0	
Temp Code (Sinewave / VFD)	0 / 0

Nameplate Drawing

Rolled Steel TEFC

TYPE	AEGHPE	CAT. NO.	RF0/545C		
OUTPUT	0.50 HP 0.37 kW	FRAME	56C	TEFC	
R.P.M.	1725	POLE	4	INS.	F
VOLTS	575	PHASE	3	Hz	60
AMPS	0.6	CODE	J	S.F.	1.15
AMBIENT	40 °C	NOM. EFF. 78.2		MIN. EFF. 75.0	
BEARINGS	6204ZZ / 6203ZZ			RATING Cont.	
SER. NO.	TBD	DESIGN	B	WT. 25 LBS	
PWM VFD DUTY	VT	CT	CP	S.F.	
	3-60Hz	6-60Hz	60-120Hz	1.0 Only	

Connection Diagram

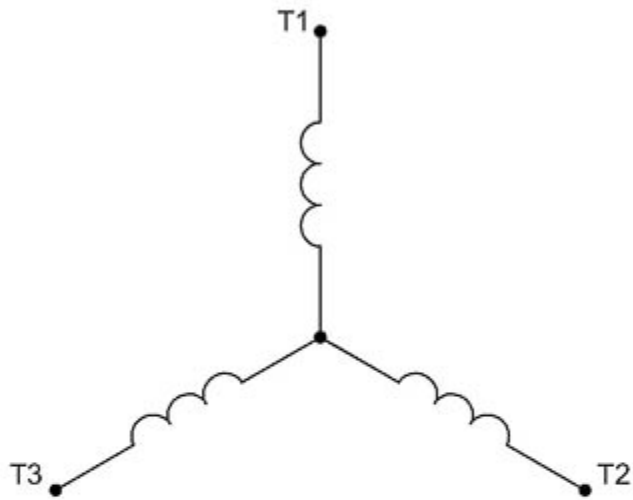

3 LEAD		SINGLE VOLTAGE			WYE
VOLTAGE	CONN.	L1	L2	L3	
-	WYE	1	2	3	

WD_3Y