

Technical Documentation

RF0012

Rolled Steel TEFC | AEGH

Date: December 1, 2016

Dimensional Drawing

Catalogue	Model	HP	Pole	kW	Rating	Voltage	Hz	RPM
RF0012	AEGH	1	2	0.75	Continuous	230 / 460 V	60	3600

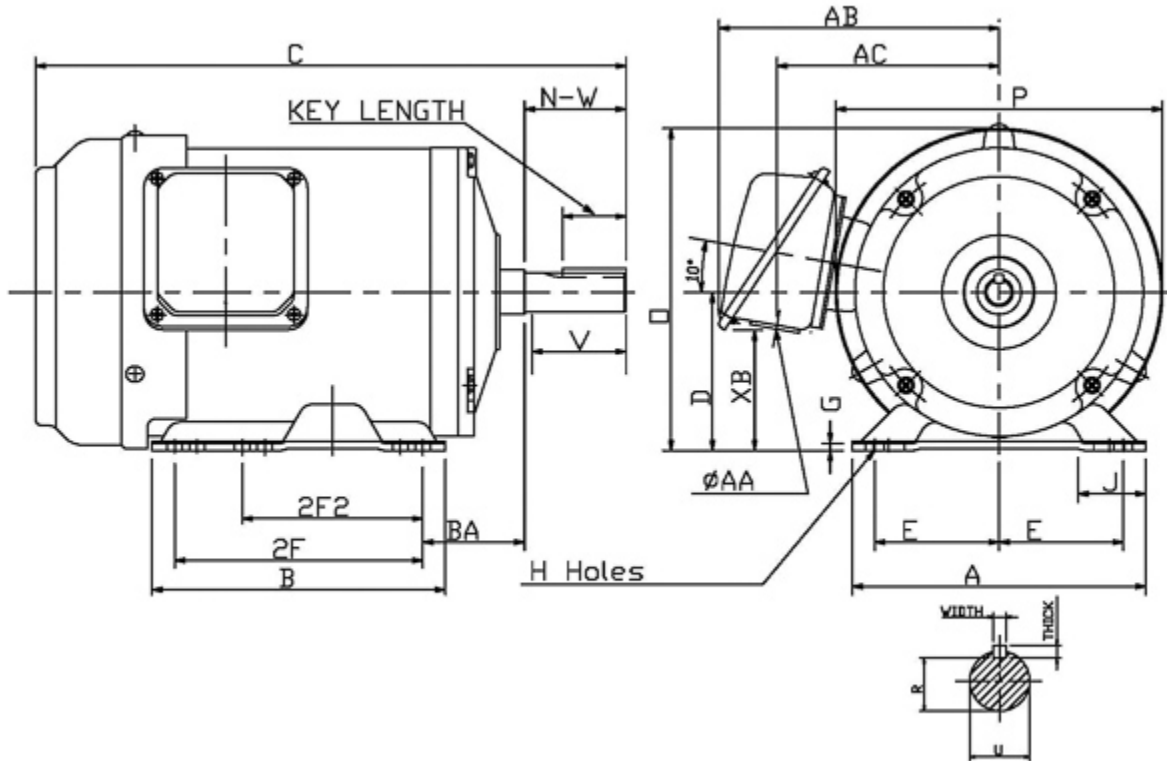

Frame Size	Mounting					A	B	C	CD	D	
	E	2F	2F2	H	BA						
143T	5.5	5	4	0.34	2.25	6.5	6.5	13.24		3.5	
G	J	K	L	M	O	P	T	Key			Keyseat
0.16	1.5				7.12	7.24		Width	Thick	Length	R
								0.188	0.188	1.41	0.711
Terminal Housing				Aux Box		C/D Flange					
AA	AB	AC	XB	AE	AX	BB	AH	AK	BD	AJ	BF
1.1	6.2	4.93	2.66								
Shaft Extension			Bearings		Approx. Weight Lbs	SPL dBA/3ft	Ins. Class	S.F.	Drive Method	Dimensions	
N-W	U	V	DE	NDE							
2.25	0.875	2.2	6205ZZ	6204ZZ	29	61	F	1.15	Direct Coupling / Belt Drive	Inches	

Technical Data Sheet

Motor Type: AEGH

Catalogue No: RF0012

Nameplate Information

HP	Pole	RPM	Frame	Voltage	Hz	Phase
1	2	3470	143T	230 / 460	60	3
Enclosure	Ins. Class	Service Factor	Time Rating	NEMA Design	Rated Amb.	Rated Altitude
TEFC	F	1.15	Continuous	B	-40 to 40 °C	<3300 ft

Typical Performance

Efficiency (%)				Power Factor (%)		
Full Load		3/4 Load	1/2 Load	Full Load	3/4 Load	1/2 Load
Nom.	Min.					
80.0	77.0	81.0	78.0	85.5	78.5	67.5
Torque				Current (A)		
Full Load (lb-ft)	Locked Rotor (% FLT)	Pull Up (% FLT)	Break Down (% FLT)	No Load	Full Load	Locked Rotor
1.51	270	235	320	1.4 / 0.7	2.7 / 1.4	30 / 15
NEMA KVA Code	Inertia (WR ²)			Safe Stall Time (s)		Noise Level Sound Press. dB(A)
	Rotor (lb-ft ²)	NEMA Load (lb-ft ²)	Max. Allowable (lb-ft ²)	Cold	Hot	
N	0.036	1.2	6	30	21	61

VFD Duty Information

Speed Range			VFD		S.F.
Constant Torque	Variable Torque	Constant Power	Carrier	Type	
6-60Hz	3-60Hz	60-120Hz	≤ 5 kHz	VPWM or CPWM	1.0 Only

Additional Information

Bearings		Approx. Weight
DE	NDE	lbs
6205ZZ	6204ZZ	29

Hazardous Locations Information

N/A	
Temp Code (Sinewave / VFD)	/

Connection Diagram



9 LEAD DUAL VOLTAGE WYE					
VOLTAGE	CONN.	L1	L2	L3	JOIN
HIGH	WYE	1	2	3	4&7,5&8,6&9
LOW	2 WYE	1,7	2,8	3,9	4&5&6

WD_9Y

Thermal Limit Curves

Motor Type: AEGH		Catalogue No: RF0012		Family: Rolled Steel TEFC	
HP	1	Safe Stall Time		Full Load A	2.7 / 1.4 A
Voltage	230 / 460V 60Hz	Hot	21 s	Locked Rotor A	1,095 / 1,095 %
RPM	3600	Cold	30 s	Locked Rotor A	30.0 / 15 A

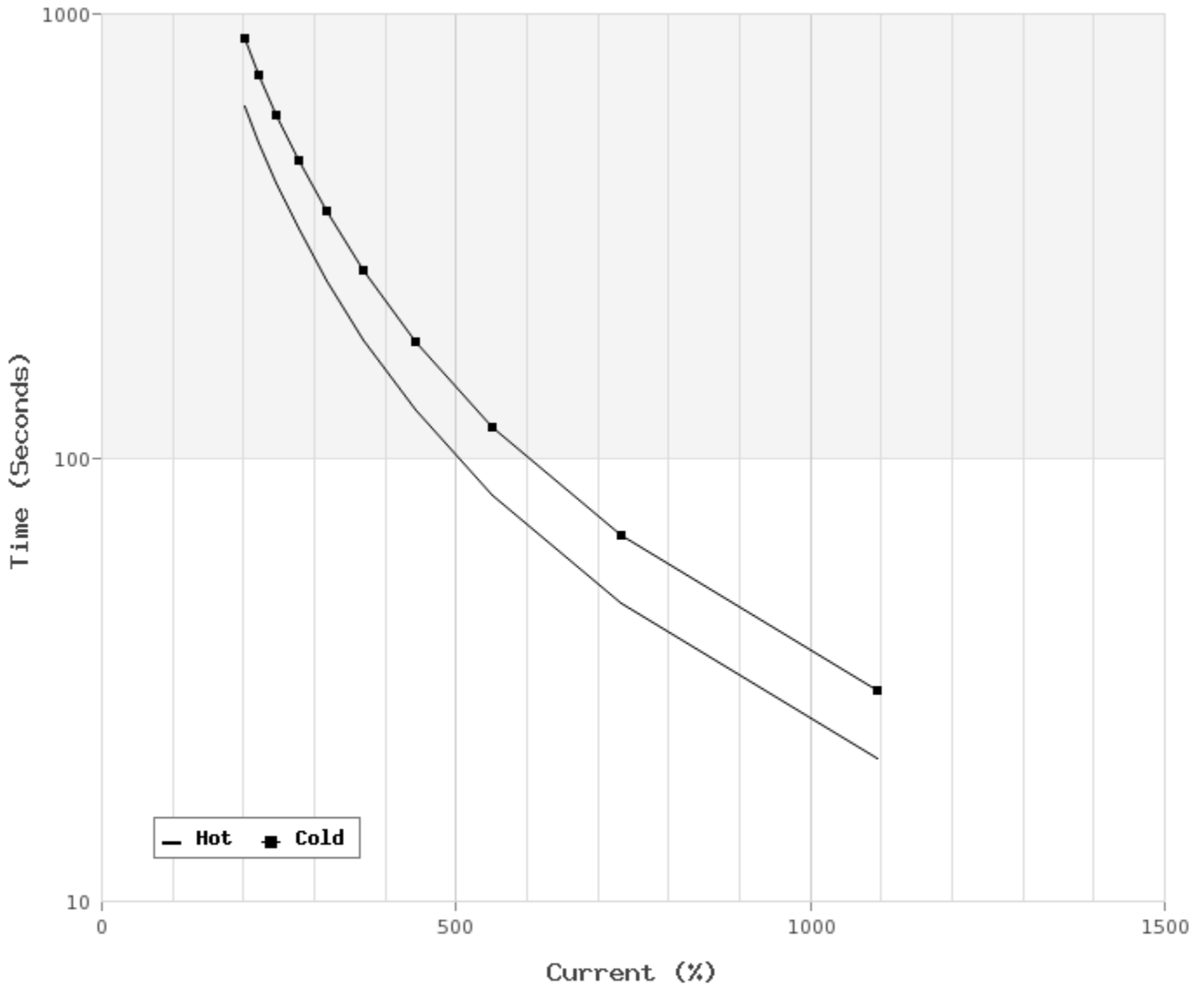

T-N and I-N Curves

Motor Type: AEGH		Catalogue No: RF0012		Family: Rolled Steel TEFC	
HP	1	Full Load T	1.51 lb-ft	Full Load A	2.7 / 1.4 A
Voltage	230 / 460V 60Hz	Locked Rotor T	270 %	Locked Rotor A	30.0 / 15.0 A
RPM	3600	Pull Up T	235 %	Break Down T	320 %

