

Technical Documentation

APH00325

Advantage Plus IEEE Ready | AEHH8R

Date: June 25, 2020

Dimensional Drawing

Catalogue	Model	HP	Pole	kW	Rating	Voltage	Hz	RPM
APH00325	AEHH8R	3	2	2.2	Continuous	575	60	3600

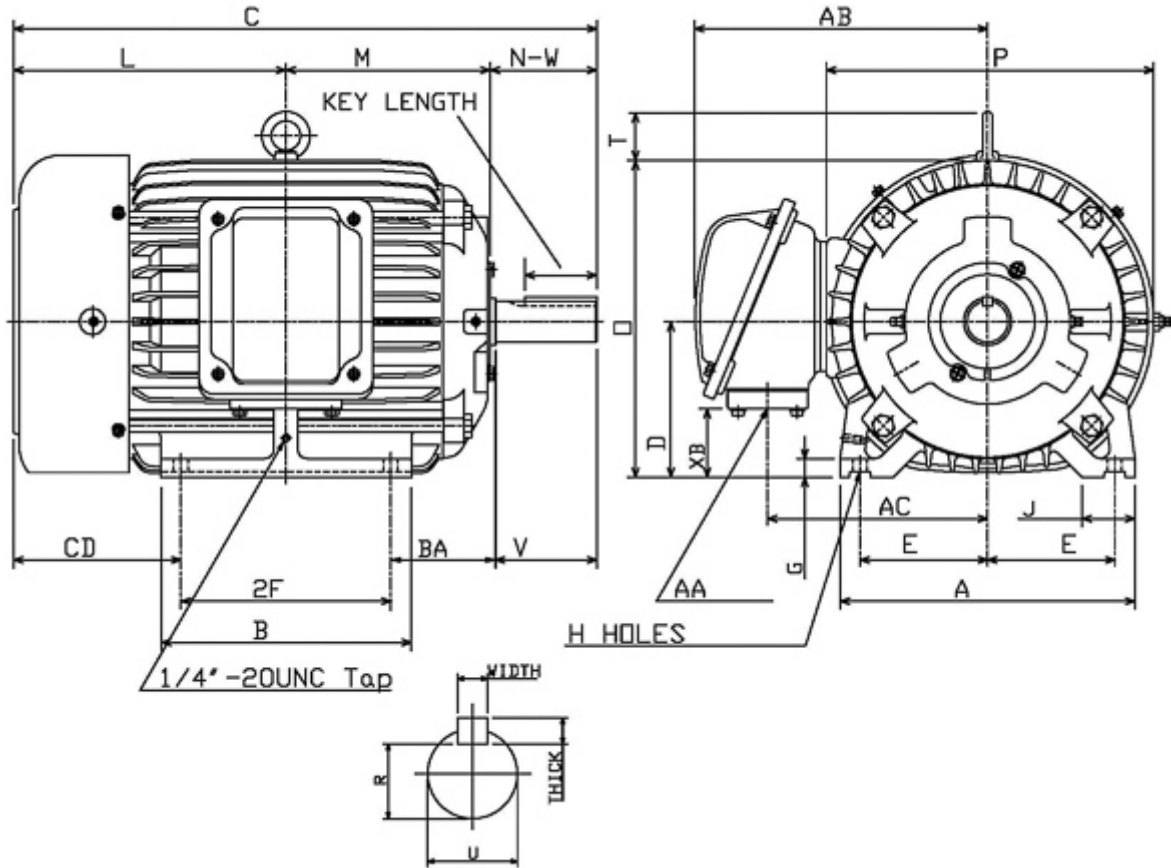

Frame Size	Mounting					A	B	C	CD	D	
	E	2F	2F2	H	BA						
182T	3.75	4.5		0.41	2.75	8.82	5.88	14.89		4.5	
G	J	K	L	M	O	P	T	Key			Keyseat
0.65	1.75		7.14	4.87	9.17	9.61	1.3	Width	Thick	Length	R
								0.25	0.25	1.78	0.986
Terminal Housing			Aux Box			C/D Flange					
AA	AB	AC	XB	AE	AX	BB	AH	AK	BD	AJ	BF
NPT3/4"	8.31	6.38	1.86								
Shaft Extension			Bearings		Approx. Weight Lbs	SPL dBA/3ft	Ins. Class	S.F.	Drive Method	Dimensions	
N-W	U	V	DE	NDE							
2.75	1.125	2.7	6306ZC3	6306ZC3	84	64	F	1.15	Direct Coupling / Belt Drive	Inches	

	
	Date: June 25, 2020

Technical Data Sheet

Motor Type: AEHH8R	Catalogue No: APH00325
--------------------	------------------------

Nameplate Information

HP	Pole	RPM	Frame	Voltage	Hz	Phase
3	2	3490	182T	575	60	3
Enclosure	Ins. Class	Service Factor	Time Rating	NEMA Design	Rated Amb.	Rated Altitude
TEFC	F	1.15	Continuous	B	-40 to 40 °C	<1000 m

Typical Performance

Efficiency (%)				Power Factor (%)		
Full Load		3/4 Load	1/2 Load	Full Load	3/4 Load	1/2 Load
Nom.	Min.					
88.5	86.5	90.2	89.5	90.0	87.0	79.5
Torque				Current (A)		
Full Load (lb-ft)	Locked Rotor (% FLT)	Pull Up (% FLT)	Break Down (% FLT)	No Load	Full Load	Locked Rotor
4.51	280	250	380	1.0	2.8	26
NEMA KVA Code	Inertia (WR ²)			Safe Stall Time (s)		Noise Level Sound Press. dB(A)
	Rotor (lb-ft ²)	NEMA Load (lb-ft ²)	Max. Allowable (lb-ft ²)	Cold	Hot	
K	0.190	3.50	13.00	17	12	64

VFD Duty Information

Speed Range			VFD		S.F.
Constant Torque	Variable Torque	Constant Power	Carrier	Type	
6-60Hz	3-60Hz	60-120Hz	≤ 5 kHz	VPWM or CPWM	1.0 Only

Hazardous Locations Information

CSA Certified
Class I, Div 2, Groups B, C & D Class I, Zone 2, Groups IIB+H2, IIB & IIA
Temp Code (Sinewave / VFD)
T3C / T3C

Additional Certifications

Other Certification
Class II, Div 2, Groups F & G

Additional Information

Bearings		Approx. Weight
DE	NDE	lbs
6306ZC3	6306ZC3	84

Nameplate Drawing

Advantage Plus IEEE Ready

TYPE	AEHH8R	CAT. NO.	APH00325		
OUTPUT	3 HP 2.2 kW	FRAME	182T	TEFC	
R.P.M.	3490	POLE	2	INS.	F
VOLTS	575	PHASE	3	Hz	60
AMPS	2.8	CODE	K	S.F.	1.15
AMBIENT	40 °C	NOM. EFF. 88.5		MIN. EFF. 86.5	
BEARINGS	6306ZC3 / 6306ZC3			RATING Cont.	
SER. NO.	TBD	DESIGN	B	WT. 84 LBS	
PWM VFD DUTY	VT	CT	CP	S.F.	
	3-60Hz	6-60Hz	60-120Hz	1.0 Only	

Connection Diagram

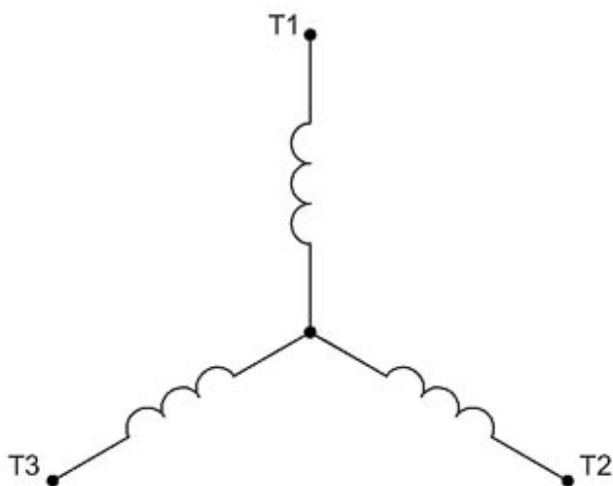

3 LEAD		SINGLE VOLTAGE			WYE
VOLTAGE	CONN.	L1	L2	L3	
-	WYE	1	2	3	

WD_3Y

Thermal Limit Curves

Motor Type: AEHH8R		Catalogue No: APH00325		Family: Advantage Plus IEEE Ready	
HP	3	Safe Stall Time		Full Load A	2.8 A
Voltage	575V 60Hz	Hot	12 s	% Inrush	922 %
RPM	3600	Cold	17 s	Locked Rotor A	26 A

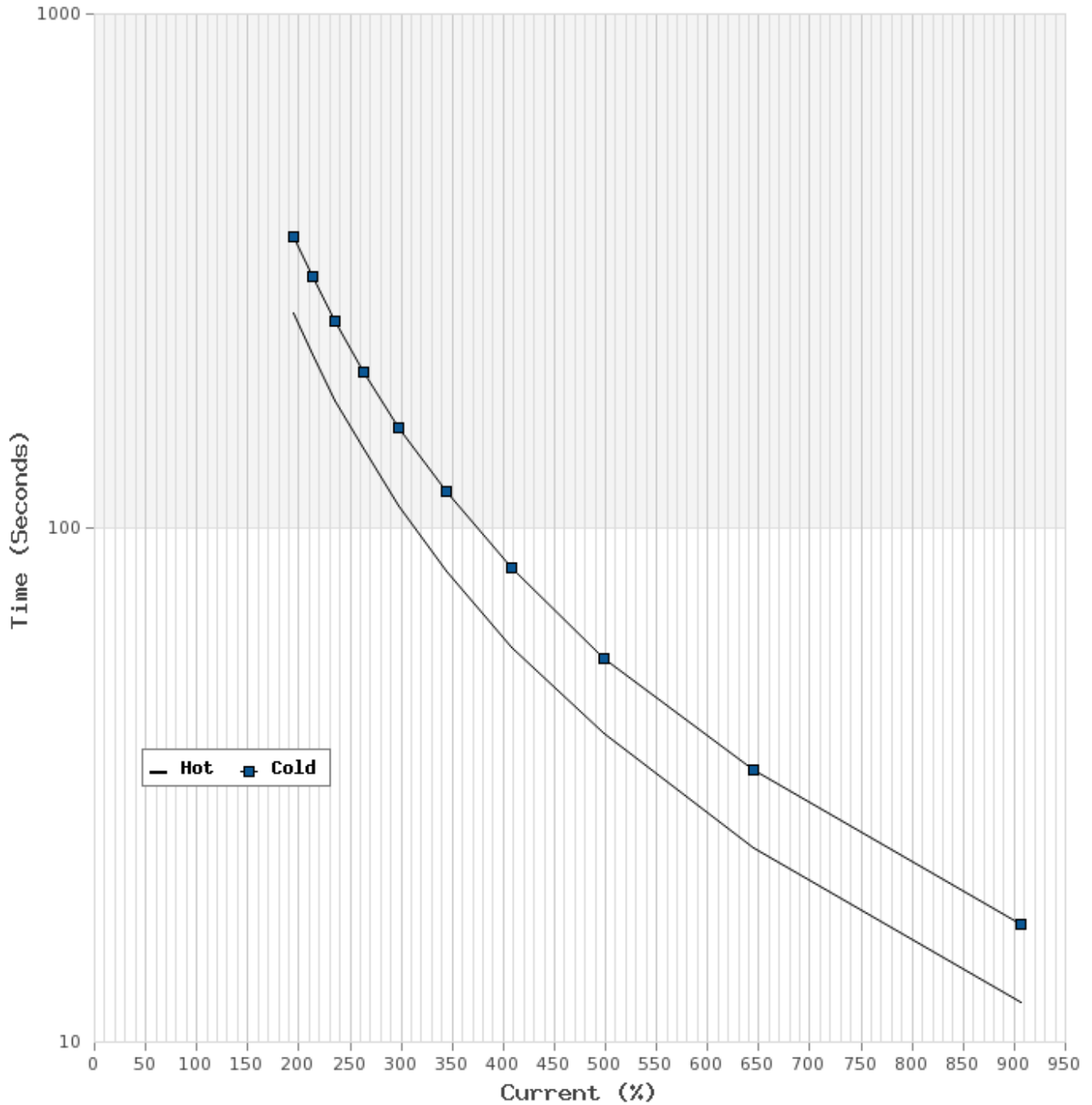

T-N and I-N Curves

Motor Type: AEHH8R		Catalogue No: APH00325		Family: Advantage Plus IEEE Ready	
HP	3	Full Load T	4.51 lb-ft	Full Load A	2.8 A
Voltage	575V 60Hz	Locked Rotor T	280 %	Locked Rotor A	26.0 A
RPM	3600	Pull Up T	250 %	Break Down T	380 %

